

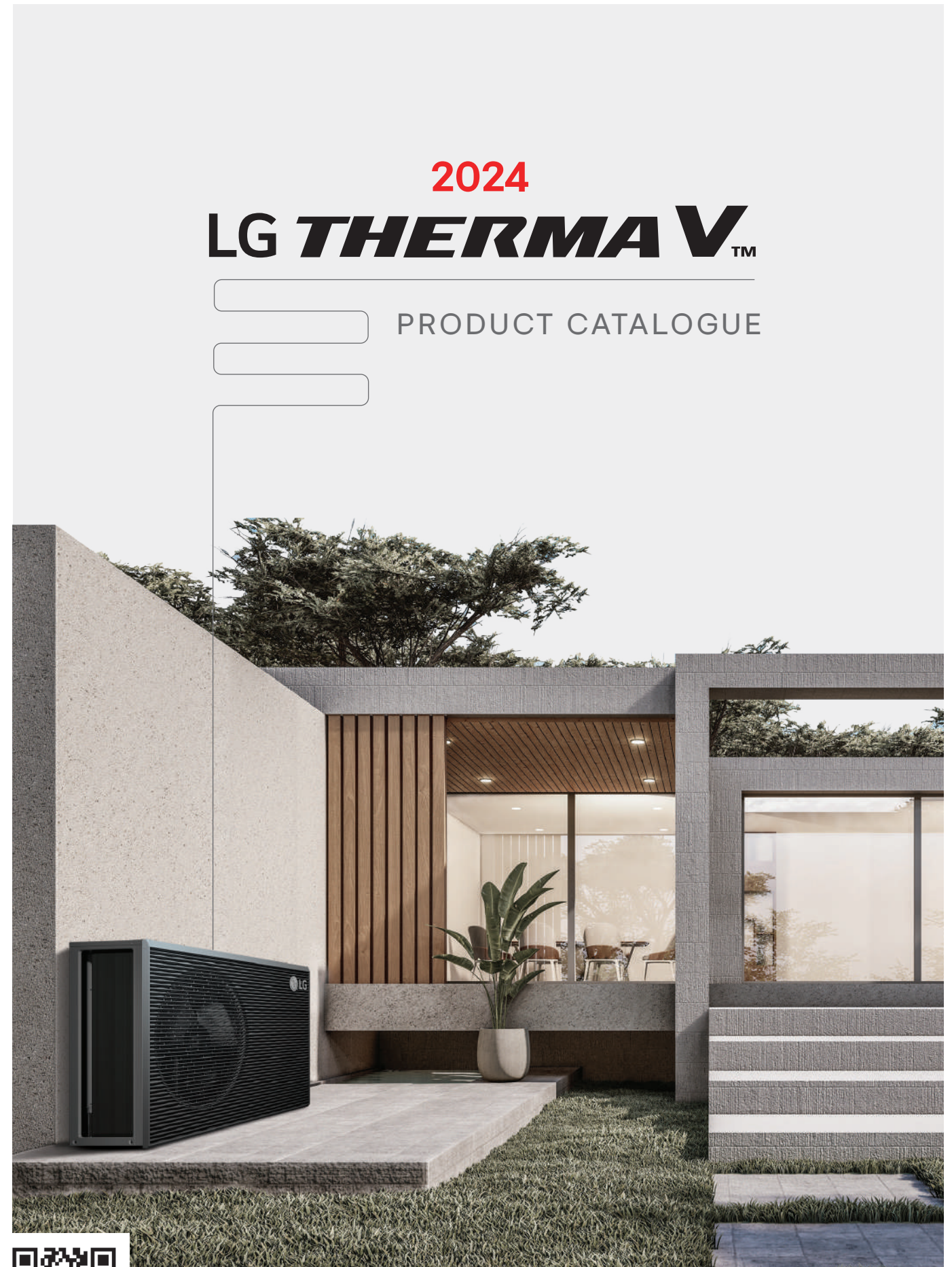

Distributed by

2024 LG THERMA V™ PRODUCT CATALOGUE



2024 LG THERMA V™

PRODUCT CATALOGUE



Browse now

For more LG THERMA V information, please visit our website through QR code.





INTRODUCTION

LG BUSINESS PARTNERSHIP & INFRASTRUCTURE	006
THE EU BUILDING SECTOR	008
HEAT PUMP TECHNOLOGY	010
REGULATIONS & CERTIFICATIONS	012
THERMA V INTRODUCTION	016
WHAT IS LG THERMA V	018
LG AIR-TO-WATER HEAT PUMP SOLUTION OVERVIEW	020
THERMA V LINE-UP OVERVIEW	022
THERMA V LINE-UP INTRODUCTION	024
PRE-SALES/ENGINEERING TOOLS	030
ThinQ SEAMLESS CONNECTIVITY	032
LG BECON CLOUD SERVICE FOR THERMA V	034
LG SMART HOME ENERGY PACKAGE	038
LG ESS RESIDENTIAL LINE UP HOME SERIES	040

THERMA V™



PRODUCTS

MONOBLOC	
NEW R290 MONOBLOC	046
R32 MONOBLOC S	058
HYDROSPLIT	
R32 HYDROSPLIT HYDRO UNIT	076
R32 HYDROSPLIT COMBI UNIT	088
SPLIT	
R32 SPLIT HYDRO UNIT	100
R32 SPLIT COMBI UNIT	116
R410A SPLIT HYDRO UNIT	138
HOT WATER HEAT PUMP	
HOT WATER HEAT PUMP	148

ACCESSORIES

ACCESSORIES PROVIDED BY LG	164
LG WI-FI MODEM	168
DOMESTIC HOT WATER TANK	169
COMBINED TEST WITH DHW TANK	170



#CareForWhereYouLive



Watch now ▶

THERMAV™

LG | Business Solutions



LG BUSINESS PARTNERSHIP & INFRASTRUCTURE

Infrastructure in Europe

LG Electronics' European Air Solution department is committed to ensuring your business success. With 16 pan-European sales offices and academies, we seek to deliver on our promise of support, efficiency and proactivity throughout each stage of our business partnership.

Our highly competitive products are delivered through our dedicated European distribution centre to ensure a steady and reliable supply of inventory.

At our European Energy Lab, LG Business Solutions is developing a heat pump technology that is optimized for the varied European climates and weather patterns along with continuous product performance verification.



LG Europe B2B Regional Head Office

LG Business Solutions Europe is based in Eschborn, Germany, with regional offices located throughout Europe. LG Europe B2B Regional Head Office is a control tower for European B2B business dealing with a wide range of products, including heat pumps and air conditioners. LG Electronics has a strong global network.

About LG Business Solutions:
<http://www.lg.com/global/business/about-lg-business>



LG Heat Pump and Air Conditioning Academy

LG has set up 20 official heat pump and air conditioning academies in Europe, teaching much needed skills to thousands of current industry professionals including installers, consultants, designers, sales staff and service technicians. The academy program is designed to share expertise and educate these HVAC experts by providing a cutting-edge technical experience with the newest and most advanced technologies and equipment. Moreover, as LG's entire product range is installed on site, professionals can be trained in a realistic way that offers them the chance to experience the latest products first-hand.



European Distribution Center

LG's European Distribution Center is located in Tilburg, the Netherlands. Supplying products all over Europe, this distribution hub has contributed to smooth and rapid delivery, direct shipping for smaller orders and delivery tailored to air conditioners. Inventory efficiency of the hub is secured by the LG EU's established inventory pool.

THE EU BUILDING SECTOR

Buildings account for 40% of the total carbon emissions in Europe. The building stock that dates back to the 90s is three times less energy efficient than new construction built today.



OF EU ENERGY IS USED BY BUILDING SECTOR, MAKING IT THE SINGLE LARGEST ENERGY CONSUMER IN EUROPE



OF GREENHOUSE GAS EMISSIONS COME FROM BUILDINGS

LG OUR MISSION

- ① Create low-consuming or self-consuming innovations
- ② Build awareness and help people use energy more conservatively
- ③ Reimagine a building's usability, connectivity, convenience & health

* Source: The European Commission website. https://commission.europa.eu/news/focus-energy-efficiency-buildings-2020-02-17_en

RE-DESIGN

IMPROVE CIRCULARITY OF RAW MATERIALS

Minimize environmental impact with our eco-conscious air conditioning solutions. By reducing reliance on finite resources such as plastic, aluminum, and copper, LG's innovative approach embraces a circular economy supply chain. This not only lessens carbon emissions during pre-manufacturing but also ensures resource efficiency, particularly for energy-hungry materials. Discover the sustainability of LG air conditioners, where recycled materials play a pivotal role. We conduct thorough stability and quality tests to guarantee optimal performance, leading the way toward a more sustainable and efficient future.

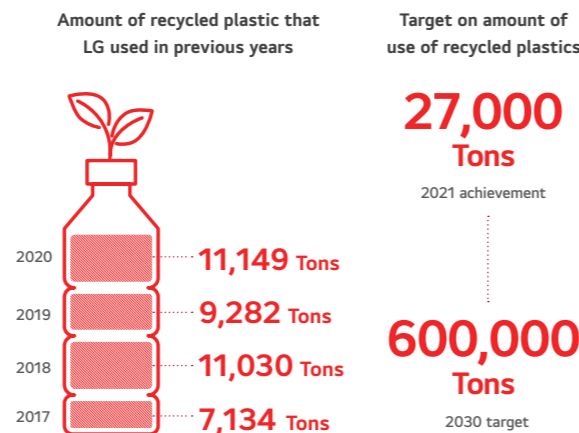

RECYCLING OLD APPLIANCES

Many reusable resources are left in discarded products. Founded in 2001 through investment from LG, the Chilseo Recycling Center acts as a virtuous cycle of resources, from product design, use, and recovery, to disposal. Engineers collect old appliances from LG and other brands, then carefully take them apart. More than 40 kinds of renewable raw materials, including separated plastic, iron, and non-ferrous metals, are reborn into new LG products.



RE-PROGRAM

ACHIEVE 95% IN WASTE RECYCLING AT PRODUCTION SITES BY 2030

At LGE, we continuously invest in environmental facilities and improve our waste treatment processes with a view to being able to recycle 95% of waste generated at production sites around the world by 2030.



INNOVATE

REDUCE RELIANCE UPON HIGH GWP REFRIGERANT GASES

Refrigerant gases contribute to global warming even though their contribution is not the biggest. LG was the first manufacturer to launch an R32 monobloc air-to-water heat pump in 2018 and have also converted our full single split line up to R32 with 3 years lead time on the EU -driven planned ban in 2025. Also, LG is likely to put in place collection and recovery streams of refrigerant gases from end of life equipment at no extra cost for its customers.

CONSTANT PRODUCT EFFICIENCY IMPROVEMENTS

Electrically-driven heating and cooling equipment is LG's signature. What's more, we always aim at the highest energy ratings, generation after generation of product launching.

Reduce carbon emissions during use of 7 major products (baseline year 2020)

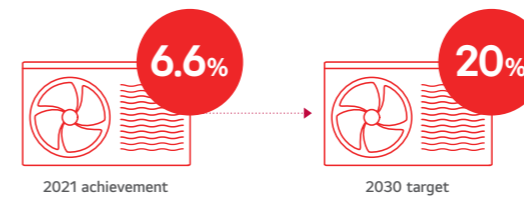

FIRST HOME APPLIANCES LIGHTHOUSE FACTORY

In March 2022, Changwon LG Smart Park was named the first 'lighthouse factory' by the World Economic Forum (WEF). The WEF "Lighthouse" facilities implement Fourth Industrial Revolution technologies, such as the Internet of Things, big data, artificial intelligence and robots, into manufacturing and supply chain operations to deliver a wide range of benefits, from increased production efficiency to enhanced environmental sustainability. LG plans to apply the innovative, smart production technologies pioneered at LG Smart Park to a total of 26 LG production facilities in 13 countries, accelerating the digital transformation of its global manufacturing network by 2025.

EDUCATE

LIFE CYCLE ANALYSIS

The Air Solution Division has assessed 4 product families, as regards their total life cycle impact, according to the French PEP certification scheme: it provides product greenhouse gas emissions from production, transport, use and end of life phases, over a period of 22 years.

Efficiency comparisons between THERMA V & differing technologies



CERTIFICATIONS

LG Electronics is listed in the:

- DJSI World for 9 consecutive years
- 2020 Global Sustainability Leadership top 100, announced by Privileged United Nations Sustainability Development Goals (UNSDGs)
- 6th place in the top 100 World Sustainable Management Companies by Wall Street Journal
- ECOVADIS Platinum certified in 2021 & 2023



HEAT PUMP TECHNOLOGY

LG Electronics Leads the Way in Heat Pump Technology

As a leading HVAC supplier, LG's heating product portfolio comprises a wide range of highly energy efficient renewable energy systems, providing the right heating solution for any type of requirements and/or buildings.

What is an Air-to-Water Heat Pump System?

Modern Technology to Replace Conventional Boilers

Historically, conventional heating systems have used either oil or gas or have represented direct electric heaters. In such conventional heating systems, environmental aspects such as the pollution produced by fossil fuel use have been overlooked. Over the last years, the interest in these environmentally friendly devices has been increasing and in order to respond to the growing demand for eco-conscious devices, LG has further developed its heat pump technology to produce more efficient, environmentally friendly products.

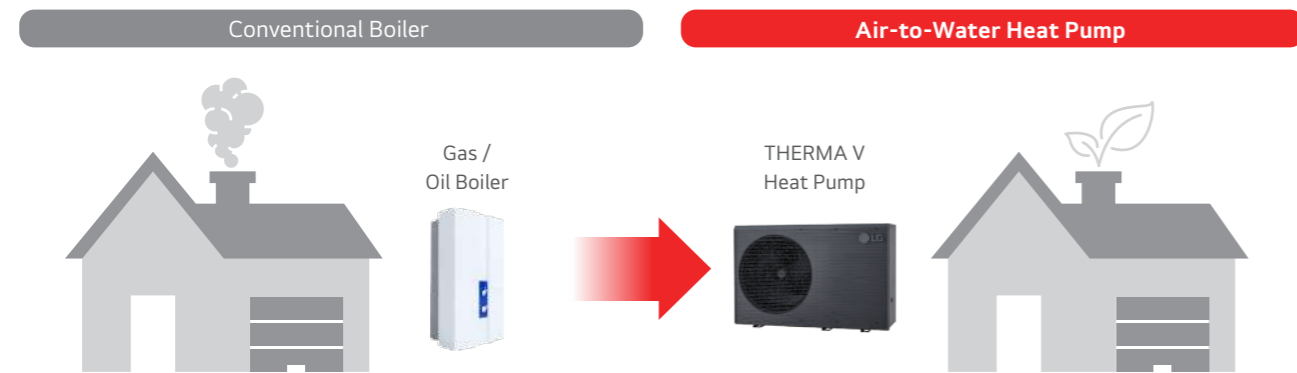

Modern Technology for Renewable Energy

The term "Heat Pump" refers to a technique that pumps heat from renewable energy sources, like the air, ground and water. A heat pump device transforms this energy into a usable heat source via the refrigerant cycle. With THERMA V heat pump technology about 75% of the energy needed to provide heating and hot water comes from a natural air source.¹⁾

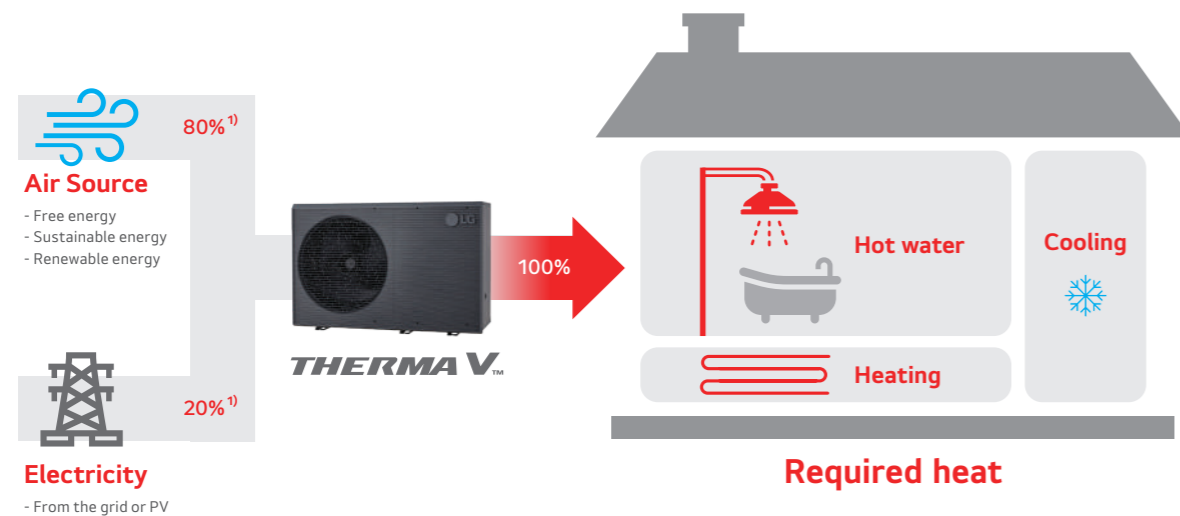

¹⁾ The efficiency ratio is to help general understanding and is based on the Seasonal Coefficient of Performance (SCOP) of THERMA V R290 Monobloc under Low Temperature & Average Climate conditions, which is higher than 5. The actual efficiency may vary with water and outside temperatures.

How do Air-to-Water Heat Pumps Work?

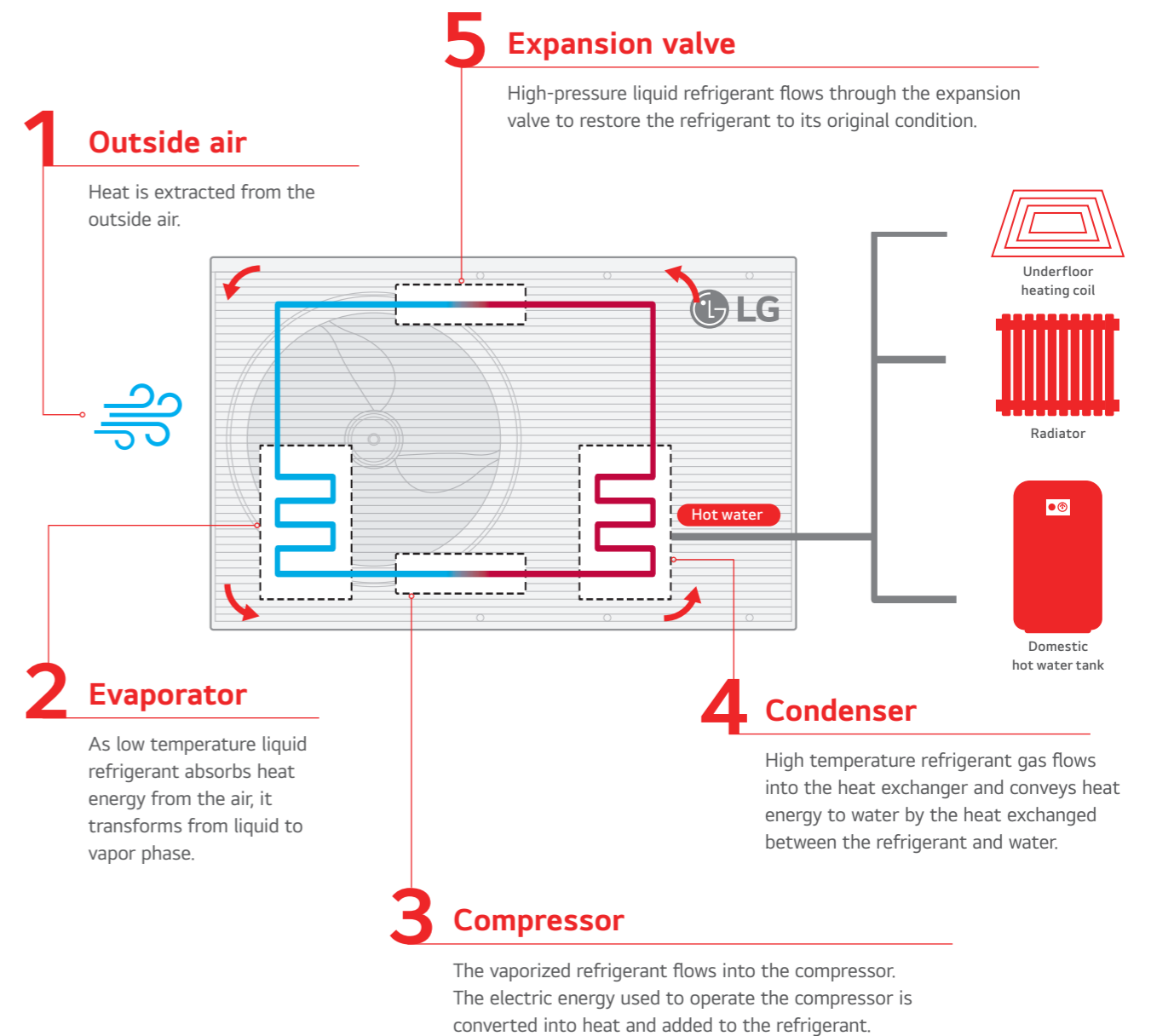

REGULATIONS & CERTIFICATIONS

Energy Label

Energy labels

The EU energy label has been a key driver for helping consumers choose products which are more energy efficient. At the same time, it also encourages manufacturers to drive innovation by using more energy efficient technologies. The energy label was recognized by 93% of consumers and 79% considered it when buying energy efficient products, according to the special eurobarometer 492 carried out in the 28 EU member states during 2019.

Starting from 2013, the regulations apply to heat pumps, as well as to water heaters since 2015.

As of September 26th, 2019, the energy efficiency scale for seasonal space heating ranges from A+++ to D, with A+++ being the most efficient. The water heating energy efficiency scale for the declared load profile for combination heat pumps ranges from A+ to F, with A+ being the most efficient.

Information on the energy label

The energy labels provide minimum necessary information such as: manufacturer's name, manufacturer's model name, seasonal space heating energy efficiency class under average climate condition from A+++ to D in medium/low temperature applications (55°C/35°C), rated heat output under average, colder and warmer climate conditions in medium/low temperature applications (55°C/35°C), European map displaying the three temperature zones, the sound power level indoors and/or outdoors. In addition, just for combination heat pumps, the energy label also includes Water heating energy efficiency class under average climate condition from A+ to F at declared load profile, while the seasonal space heating energy efficiency class and rated heat output are indicated only for the medium temperature application (55°C).

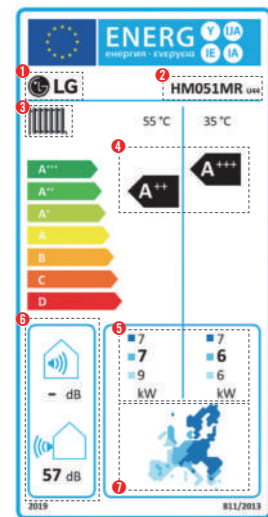

Heat pump space heaters

- 1 Manufacturer's name or trade mark
- 2 Manufacturer's model name
- 3 Space heating function
- 4 Seasonal space heating energy efficiency class under average climate condition from A+++ to D in medium/low temperature applications (55°C/35°C)
- 5 Rated heat output (kW) under average, colder and warmer climate conditions in medium/low temperature applications (55°C/35°C)
- 6 Operating noise for indoor and outdoor
- 7 European map displaying the three temperature zones

* This energy label may differ depending on local regulations (for example in the UK).

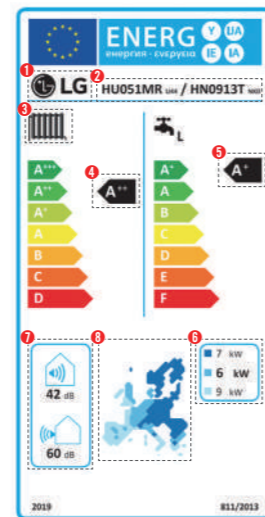

Heat pump combination heaters

- 1 Manufacturer's name or trade mark
- 2 Manufacturer's model name
- 3 Space heating function
- 4 Seasonal space heating energy efficiency class under average climate conditions from A+++ to D in medium temperature applications (55°C)
- 5 Water heating energy efficiency class under average climate conditions from A+ to F
- 6 Rated heat output (kW) under average, colder and warmer climate conditions in medium temperature application (55°C)
- 7 Operating noise for indoor and outdoor
- 8 European map displaying the three temperature zones

* This energy label may differ depending on local regulations (for example in the UK).

Nearly Zero Energy Building (nZEB)

Nearly Zero Energy Building

Nearly Zero-Energy Building (nZEB) means a building that has a very high energy performance, while the nearly zero or very low amount of energy required should be covered to a very significant extent by energy from renewable sources, including energy from renewable sources produced on-site or nearby. The Energy Performance of Buildings Directive (EPBD) requires that EU countries ensure that all new buildings are nearly zero-energy by the end of 2020, while all new public buildings had to be nearly zero-energy after 31 December 2018.

As concrete numeric thresholds or ranges are not defined in the EPBD, each EU member state defines their Nearly Zero-Energy Buildings (nZEB) in a flexible way, taking into account their country-specific climate conditions, primary energy factors, calculation methodologies, building traditions and current ambitions.

How LG THERMA V supports to Nearly Zero Energy Buildings (nZEB)

In general, consultants use software programs to evaluate nZEB satisfaction of a new building. LG has been registering THERMA V products in their database so that our THERMA V products can be used directly in these software programs such as BENG in Netherlands, SAP in UK and RE2020 in France.

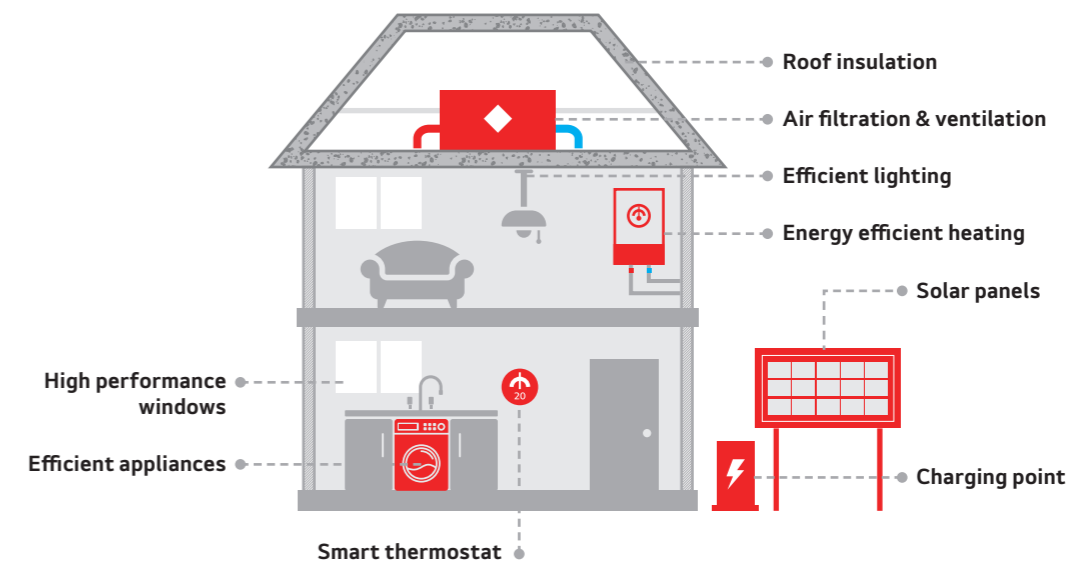

LG THERMA V energy labels | Energy labels for each LG THERMA V model can be found on the websites below.



LG.COM -
Compliance Information
<https://www.lg.com/global/support/cedoc/cedoc>

Browse now



EPREL -
European Product Registry for Energy Labelling
<https://eprel.ec.europa.eu/screen/product/spaceheaters>

Browse now



Netherland -
BENG
<https://bcrg.nl/verklaringenregister/>

Browse now



UK -
SAP
<https://www.ncm-pcdb.org.uk/sap/pcdbsearch.jsp?type=362&pid=31>

Browse now



France -
RE2020
<https://www.edibatec.org/base-produits/>

Browse now

REGULATIONS & CERTIFICATIONS

Certifications

All heat pumps and water heaters in the European market are continuously tested by various certification schemes. These are usually the basis for qualifying for subsidy programs in each country.



Keymark

<https://keymark.eu/en/products/heatpumps/certified-products>

[Browse now](#)



The heat pump Keymark is a voluntary, independent European certification mark (ISO type 5 certification) for all heat pumps, combination heat pumps and hot water heaters (as covered by ecodesign, EU regulation 813/2013 and 814/2013). It is based on independent, third party testing and demonstrates compliance with product requirements as set in the heat pump Keymark scheme rules and with efficiency requirements as set by ecodesign lot 1 and lot 2.

The heat pump Keymark scheme is owned by the European committee for standardization (CEN).

The certificates are granted by independent certification bodies to products fulfilling all requirements of the scheme. LG THERMA V products are certified with the heat pump Keymark. Please, refer to the web page above for details.



Eurovent

<https://www.eurovent-certification.com/en/>

[Browse now](#)



Established in 1993, Eurovent certita certification is recognized as a world leader in third-party product performance certification in the heating, ventilation, air conditioning and refrigeration fields. Its major certification brand 'Eurovent Certified Performance' has become over the years a major European certification. Today over 67% of HVAC-R products sold in Europe hold this certification. LG THERMA V products are certified with Eurovent. Please, refer to the web page above for details.



MCS

<https://mcs-certified.com/product-directory/>

[Browse now](#)



MCS certification is a mark of quality and demonstrates compliance to industry standards. It is supported by the department for business, energy & industrial strategy of the UK. In particular, MCS certification demonstrates the quality and reliability of products in the renewable technology sector and it ensures that products are compliant with the UK regulations.

LG THERMA V products are certified with MCS. Please, refer to the web page above for details.



EHPA

<https://www.ehpa.org/quality/quality-label/>

[Browse now](#)



The EHPA quality label is a label that shows the end-consumer a quality heat pump unit or model range on the market. The heat pumps that receive the label need to undergo tests according to the international standard EN14511 and EN16147. These tests are executed by EN17025 accredited test centres.

LG THERMA V products are certified with the EHPA quality label for Austria, Germany and Switzerland. Please, refer to the web page above for details.

THERMA V™ INTRODUCTION

THE SUSTAINABLE CHOICE



RELIABLE
FUTURE-PROOF
ECO-RESPONSIBLE

THERMA V™



Today's informed consumer will consider multiple factors when choosing a heating solution, like an Air-to-Water Heat Pump (AWHP or ASHP) to include user-friendliness, reliability and regulation-compliance. Shifting regulations year after year exceedingly impact the European customers' choice of heating products.

With refrigerant regulations changing around the world, it's time to move to a more eco-conscious solution. THERMA V R290 Monobloc uses natural R290 refrigerant which has a lower tonne of CO2 equivalent index than other gases such as R32. Possible carbon emission from refrigerants is reduced by 99.7% compared to previous R32 Monobloc. The R290 can be vented directly into the atmosphere without any impact on the climate because it's eco-conscious refrigerant with nearly zero carbon emissions.

LG Electronics' THERMA V line-up fulfills both European regulations as well as customer needs.

THERMA V™

WHAT IS LG THERMA V?

For more LG THERMA V information, please visit our website through QR code.



[Browse now](#)

LG's Advanced Heating Technology

The LG THERMA V Air-to-Water Heat Pump system boasts an advanced heating technology that can minimize energy consumption more than any other solution in the market. In addition, it has been specially designed to provide a valuable living space and domestic hot water supply to both new build and renovated homes.



THERMA V™

Space heating

The wide span THERMA V systems with high efficiency can cover heating loads of various types of houses.

Domestic hot water

As the hot water efficiency becomes more and more important, THERMA V can provide an optimized solution for this.

Space cooling

THERMA V is a single device that can also provide a cooling solution besides the heating and hot water provided by boilers.

High Efficiency and Low CO₂ Emission

Energy & cost saving

CO₂ emission



Conventional boiler



LG THERMA V



Conventional boiler



LG THERMA V

Benefits of LG THERMA V



For installers and service providers

- Time savings with features for quicker installation and commissioning
- Less manpower for handling with the compact size and light weight
- Less service visit with high reliability and durable equipment
- Intuitive controller interface for all LG products, requiring less training
- Remote control, monitoring and diagnosis to avoid unnecessary site visits
- Clip connections for quick maintenance and no need for special tools



For consultants and designers











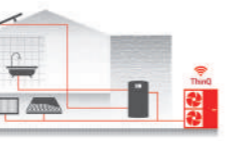

- Variety of software to support selection and designing THERMA V
- Multiple solutions with space heating, cooling and DHW supply
- Wide leaving water temperature - compatible with various heat emitters
- Valuable space savings with the small footprint
- Excellent heating performance even at low ambient temperature
- Optimal system interoperability - open modbus with 3rd party controller
- Adapts operation to ESS battery output, maximizing self-consumption of locally produced PV energy

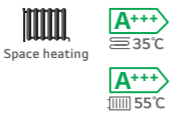

For homeowners

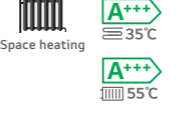
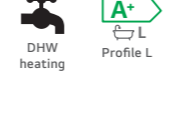

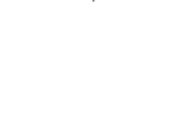
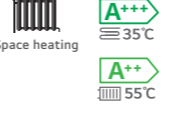
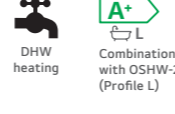

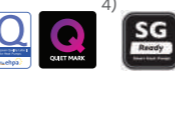









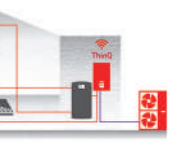

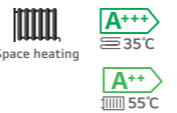

- Energy saving by utilizing renewable energy and high efficiency equipment
- Multiple solutions with space heating, cooling and DHW supply
- Economic support through domestic renewable heat incentive programs
- Investment cost savings thanks to the compatibility with existing heating system like radiator, boiler, etc.
- Valuable space savings with the small footprint
- No disturbing caused to neighbors with low noise
- Low repair cost and high reliability with durable equipment
- Convenient control by user-friendly remote controller
- Remote connectivity for control and monitoring via LG ThinQ

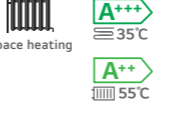
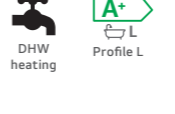
LG AIR-TO-WATER HEAT PUMP SOLUTION OVERVIEW

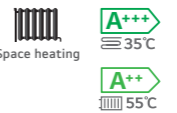
		Monobloc			
Line-up		 R290 Monobloc Control Unit	 R290 Monobloc Hydro Unit	 R290 Monobloc Combi Unit ¹⁾	 R32 Monobloc S
Application		  			
Energy label		 Space heating 35°C A+++  55°C A+++	 Space heating 35°C A+++  55°C A+++	 Space heating 35°C A+++  55°C A+++  DHW heating A+  Profile L	 Space heating 35°C A+++  55°C A+++  DHW heating A+  Combination with OSHW-200F (Profile L)
Certifications		To be acquired ¹⁾		To be acquired ¹⁾	
Operation range (heating)		Outdoor air: -28 ~ 35°C Leaving water: 15 ~ 75°C	Outdoor air: -28 ~ 35°C Leaving water: 15 ~ 75°C	Outdoor air: -28 ~ 35°C Leaving water: 15 ~ 75°C	Outdoor air: -25 ~ 35°C Leaving water: 15 ~ 65°C
Operation range (cooling)		Outdoor air: 5 ~ 48°C Leaving water: 5 ~ 27°C	Outdoor air: 5 ~ 48°C Leaving water: 5 ~ 27°C	Outdoor air: 5 ~ 48°C Leaving water: 5 ~ 27°C	Outdoor air: 5 ~ 48°C Leaving water: 5 ~ 27°C
Operation range (hot water)		15 ~ 65°C ⁶⁾	15 ~ 65°C ⁶⁾	15 ~ 65°C ⁶⁾	15 ~ 55°C ⁶⁾
Domestic hot water tank included		X	X	O (200 l)	X
Backup heater included		X	O	O	X (accessory)
F-gas license needed		X	X	X	X
Wi-Fi remote control via ThinQ ¹⁾		O	O	O	O

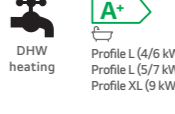

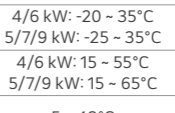
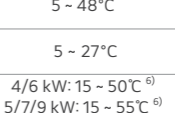
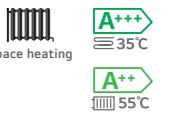













1) The Combi Unit are under development, those will be launched within this year.
2) Wi-Fi modem (PWFMD200) should be purchased and installed separately.
3) Except for 3 Ø 9 kW model (HM093MR U44)

4) 5, 7, 9 and 12 kW models only (HM051MR U44, HM071MR U44, HM091MR U44, HM093MR U44, HM121MR U34, HM123MR U34)
5) 3 Ø models only
6) With electric boost heater up to 80°C possible

		Hydrosplit		Split		
Line-up		 R32 Hydrosplit Hydro Unit	 R32 Hydrosplit Combi Unit	 R32 Split Hydro Unit	 R32 Split Combi Unit	 R410A Split Hydro Unit
Application		  				
Energy label		 Space heating 35°C A+++  55°C A+++	 Space heating 35°C A+++  55°C A+++  DHW heating A+  Profile L	 Space heating 35°C A+++  55°C A+++	 Space heating 35°C A+++  55°C A+++  DHW heating A+  Profile L (4/6 kW)  Profile L (5/7 kW)  Profile XL (9 kW)	 Space heating 35°C A+++  55°C A+++
Certifications		MCS CERTIFIED		MCS CERTIFIED		
Operation range (heating)		-25 ~ 35°C	-25 ~ 35°C	4/6 kW: -20 ~ 35°C 5/7/9 kW: -25 ~ 35°C	4/6 kW: -20 ~ 35°C 5/7/9 kW: -25 ~ 35°C	-25 ~ 35°C
Operation range (cooling)		5 ~ 48°C	5 ~ 48°C	5 ~ 48°C	5 ~ 48°C	5 ~ 48°C
Operation range (hot water)		15 ~ 55°C ⁶⁾	15 ~ 55°C ⁶⁾	4/6 kW: 15 ~ 55°C 5/7/9 kW: 15 ~ 65°C	4/6 kW: 15 ~ 55°C 5/7/9 kW: 15 ~ 65°C	15 ~ 50°C ⁶⁾
Domestic hot water tank included		X	O (200 l)	X	O (200 l)	X
Backup heater included		X (accessory)	O	O	O	O
F-gas license needed		X	X	O	O	O
Wi-Fi remote control via ThinQ ¹⁾		O	O	O	O	O

THERMA V™





LINE-UP OVERVIEW

Line-up	Unit	Type	Power supply	Appearance	4kW	6kW	Appearance	5kW
R290 Monobloc P. 046	Outdoor Unit	-	1 Ø / 230 V 3 Ø / 400 V					
	Indoor Unit	Control Unit	Common					
		Hydro Unit	1 Ø / 230 V 3 Ø / 400 V ¹⁾					
		Combi Unit	1 Ø / 230 V 3 Ø / 400 V ¹⁾					
R32 Monobloc S P. 058	Set	-	1 Ø / 230 V 3 Ø / 400 V					HM051MR U44
R32 Hydrosplit P. 076	Outdoor Unit	-	1 Ø / 230 V 3 Ø / 400 V					
	Indoor Unit	Hydro Unit	Common					
		Combi Unit	Common					
R32 Split P. 100	Outdoor Unit	-	1 Ø / 230 V		HU041MR U20	HU061MR U20		HU051MR U44
	Indoor Unit	Hydro Unit	1 Ø / 230 V		HN0613M NK5			HN091MR NK5
		Combi Unit	1 Ø / 230 V		HN0613T NK0			HN0913T NK0
R410A Split P. 138	Outdoor Unit	-	1 Ø / 230 V 3 Ø / 400 V					
	Indoor Unit	Hydro Unit	1 Ø / 230 V 3 Ø / 400 V					

- 1) This is the power specifications of the backup heater inside indoor unit, and the main power supply of the indoor unit is single phase (1 Ø / 230 V).
 2) The Combi Unit are under development, those will be launched within this year.
 3) Combinations for 1 Ø outdoor units.
 4) Combinations for 3 Ø outdoor units.

Line-up	Power supply	Appearance	200 l	270 l
Hot water heat pump P. 148	1 Ø / 230 V		WH20S	WH27S

* Production of this product could be discontinued without prior notice considering manufacturer's circumstances.

7kW	9kW	Appearance	12kW	14kW	16kW
			HM121HF UB60	HM141HF UB60	HM161HF UB60
	HM093HFX UB60		HM123HF UB60	HM143HF UB60	HM163HF UB60
	PHCS0		PHCS0		
			HN1616HC NK0 ³⁾		
	HN1639HC NK0 ⁴⁾		HN1639HC NK0 ⁴⁾		
			HN1616HY NK0 ^{2,3)}		
	HN1636HY NK0 ^{2,4)}		HN1636HY NK0 ^{2,4)}		
HM071MR U44	HM091MR U44		HM121MR U34	HM141MR U34	HM161MR U34
	HM093MR U44		HM123MR U34	HM143MR U34	HM163MR U34
			HU121MRB U30	HU141MRB U30	HU161MRB U30
			HU123MRB U30	HU143MRB U30	HU163MRB U30
			HN1600MC NK1		
			HN1616Y NB1		
HU071MR U44	HU091MR U44				
HN091MR NK5					
HN0913T NK0					
			HU121MA U33	HU141MA U33	HU161MA U33
			HU123MA U33	HU143MA U33	HU163MA U33
			HN1616M NK5 ³⁾		
			HN1636M NK5 ⁴⁾		

LINE-UP INTRODUCTION



R290 Monobloc

The new R290 Monobloc is a super-quiet, future-conscious heat pump that uses the R290 refrigerant which has lower GWP of only three. Refined grey design allows it to seamlessly harmonize with a diverse range of home and building exteriors and thanks to its low noise level, you don't have to worry about finding an installation location that won't disturb your neighbors. The LG THERMA V R290 Monobloc is available in three different combinations (Control Unit, Hydro Unit or Combi Unit¹⁾) depending on the customers' needs. By adopting a high-efficiency compressor leveraging injection technology, R290 Monobloc can deliver a leaving water temperature of up to 75 degrees Celsius all year round. Thus, this unit is suitable for renovation house since such high temperature of water is compatible with previously installed radiator systems. Moreover, thanks to the LG's renowned compressor technology, the THERMA V R290 Monobloc is able to maintain a comfortably warm indoor temperature even when it's a freezing-cold negative 28 degrees Celsius outside.

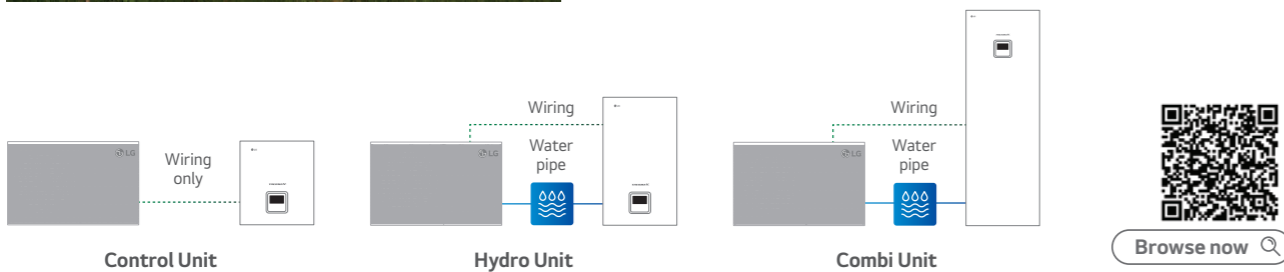

Line-up	Capacity (kW)	4.0	5.5	6.0	7.0	9.0	12.0	14.0	16.0
R290 Monobloc	1 Ø 230 V						•	•	•
	3 Ø 400 V					•	•	•	•

¹⁾ The Combi Unit are under development, those will be launched within this year.
* The power supply is shown based on the outdoor unit.



R32 Monobloc S

The THERMA V R32 Monobloc S is the 2nd generation of LG's R32 Monobloc series. As implied by "silence" and "supreme," it boasts reduced noise level and best performance in the THERMA V Series. Combining the indoor and outdoor as one module, it's also connected by only water piping eliminating the need for refrigerant piping. Furthermore, hydronic components like the plate heat exchanger, expansion tank, water pump, flow sensor, pressure sensor, air vent valves, and safety valve are conveniently situated inside the unit. The R32 Monobloc S provides excellent heating performance, especially at low ambient temperature, while producing lower carbon emissions with R32.

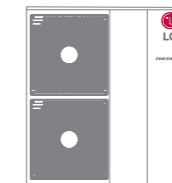

[Browse now](#)

Line-up	Capacity (kW)	4.0	5.5	6.0	7.0	9.0	12.0	14.0	16.0
R32 Monobloc S	1 Ø 230 V		•		•	•	•	•	•
	3 Ø 400 V					•	•	•	•



R32 Hydrosplit Hydro Unit

The LG THERMA V Hydrosplit series separates the indoor unit (IDU) and outdoor unit (ODU), connecting them via water pipes. The unit's heat exchanger is located within the ODU, reducing the risk of indoor refrigerant leakage. THERMA V R32 Hydrosplit Hydro Box is a solution providing space heating, cooling and DHW supply with high installation flexibility thanks to the characteristic of being a wall mounted type. Since the indoor unit is installed on the wall rather than on the floor, space is not wasted, and the light weight enables quick installation. Also, it has good maintainability because the indoor unit is located indoors, for example in a machine room.

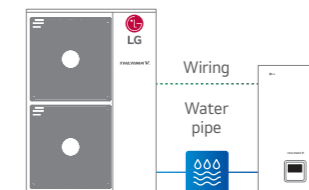

[Browse now](#)

Line-up	Capacity (kW)	4.0	5.5	6.0	7.0	9.0	12.0	14.0	16.0
R32 Hydrosplit Hydro Unit	1 Ø 230 V						•	•	•
	3 Ø 400 V						•	•	•

* The power supply is shown based on the outdoor unit.

LINE-UP INTRODUCTION



R32 Hydrosplit Combi Unit

The LG THERMA V Hydrosplit series separates the indoor unit (IDU) and outdoor unit (ODU), connecting them via water pipes. The unit's heat exchanger is located within the ODU, reducing the risk of indoor refrigerant leakage. THERMA V R32 Hydrosplit Combi Unit combines an indoor unit, a water tank and complex piping into a single, space-saving solution that is able to provide space heating, cooling and DHW supply. Relatively compact and lightweight, the innovative all-in-one is easy to install and operate, and boasts the outstanding reliability and efficiency. Since there is no need to install a separate domestic hot water tank for hot water supply, space is not wasted, and the concept with all-in-one enables quick installation.

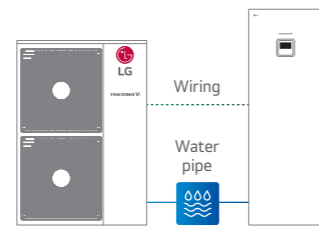

[Browse now](#)

Line-up	Capacity (kW)	4.0	5.5	6.0	7.0	9.0	12.0	14.0	16.0
R32 Hydrosplit Combi Unit	1 Ø 230 V						●	●	●
	3 Ø 400 V						●	●	●

* The power supply is shown based on the outdoor unit.



R32 Split Combi Unit

The LG THERMA V R32 Split Combi Unit is a domestic hot water supply, space heating and cooling solution that conveniently combines an indoor hot water tank with a separate outdoor unit. THERMA V R32 Split Combi Unit is the perfect space-saving solution for residential applications because hydronic components like the Domestic Hot Water (DHW) and buffer tanks, which are typically installed separately, are fully integrated. Also, freezing will not compromise this unit regardless of outdoor ambient temperatures due to the split nature. The outdoor unit is on offer in 4/6 kW and 5/7/9 kW capacity range. R32 Split 4/6 kW model is suitable for new build houses that are well insulated and require a small heating load, while R32 Split 5/7/9 kW model is adapted for both new build and renovation projects.

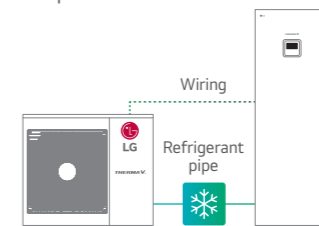

[Browse now](#)

Line-up	Capacity (kW)	4.0	5.5	6.0	7.0	9.0	12.0	14.0	16.0
R32 Split Combi Unit	1 Ø 230 V	●	●	●	●	●			
	3 Ø 400 V								

* The power supply is shown based on the outdoor unit.



R32 Split Hydro Unit

The LG THERMA V R32 Split Hydro Unit is a hydro type system consisting of an indoor unit and an outdoor unit. The two units are connected by refrigerant piping only, thus hydronic components such as plate heat exchanger, expansion tank and water pump are located within the indoor unit. Due to the split nature, freezing will not compromise this unit regardless of outdoor ambient temperatures. The outdoor unit is on offer in 4/6 kW and 5/7/9 kW capacity range. R32 Split 4/6 kW model is suitable for new build houses that are well insulated and require a small heating load, while R32 Split 5/7/9 kW model is adapted for both new build and renovation projects.

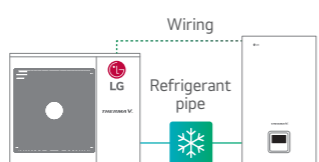

[Browse now](#)

Line-up	Capacity (kW)	4.0	5.5	6.0	7.0	9.0	12.0	14.0	16.0
R32 Split Hydro Unit	1 Ø 230 V	●	●	●	●	●			
	3 Ø 400 V								

* The power supply is shown based on the outdoor unit.



R410A Split Hydro Unit

The LG THERMA V R410A Split Hydro Unit is a hydro type system consisting of an indoor unit and an outdoor unit. The two units are connected by refrigerant piping only, thus hydronic components such as the plate heat exchanger, expansion tank and water pump are located within the indoor unit. Due to the split nature, freezing will not compromise this unit regardless of outdoor ambient temperatures. LG's THERMA V R410A Split Hydro Unit is designed for the benefit of users and installers who want to apply a heating solution to a large capacity building or applications subject to colder climate conditions. It has a maximized energy efficiency of A++ in the mid-temperature ranges, which results in reduced operating costs.

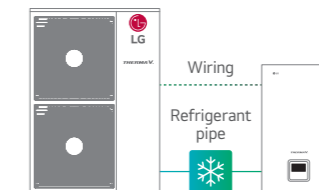

[Browse now](#)

Line-up	Capacity (kW)	4.0	5.5	6.0	7.0	9.0	12.0	14.0	16.0
R410A Split Hydro Unit	1 Ø 230 V						●	●	●
	3 Ø 400 V						●	●	●

* The power supply is shown based on the outdoor unit.

THERMA V™ LINE-UP INTRODUCTION



Browse now

What is the THERMA V Hot Water Heat Pump?

As interest in eco-conscious energy solutions grows, there is an increasing demand to replace existing electric and gas water heaters with heat pump water heaters utilizing heat pump technology. THERMA V Hot Water Heat Pump, the brand name for LG heat pump water heaters, gets 75% of its energy from outside air. This renewable energy source uses two heat exchangers, a condenser and an evaporator to produce domestic hot water.

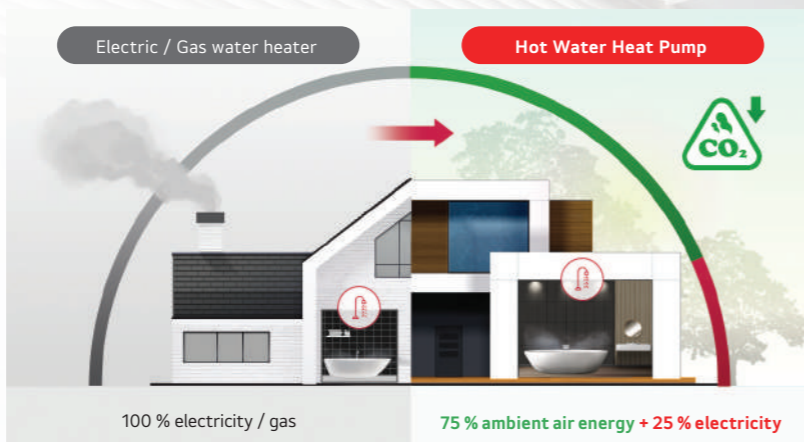

LG inverter technology

LG inverter technology can be found in many of LG's renowned devices, from refrigerators and washing machines to our air conditioner line-up. This technology allows the inverter compressor to achieve superior energy efficiency, hot water heating performance and comfort compared to compressors with on-off capabilities which is rare for monobloc heat pump water heaters.

Power consumption change

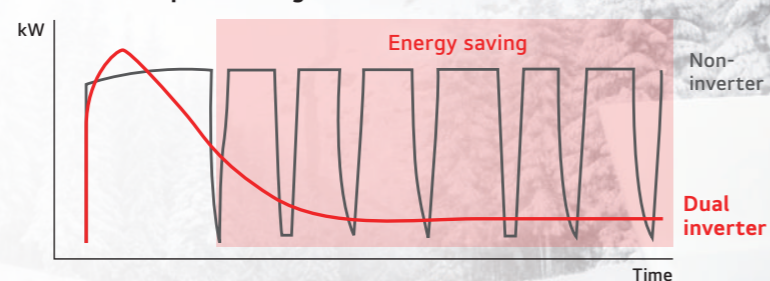

DUAL Inverter Compressor

- The top class efficiency
- Hot water performance ↑
- Low noise operation
- Various operation mode

Smart control

- Wi-Fi embedded
- Smart diagnosis
- Easy check & monitoring

LG design identity

- Premium interior design

Hygiene & durable tank

- Anti-legionella
- Impressed current titanium anode
- 10 year warranty

Line-up	Power supply	200 L	270 L
Hot Water Heat Pump	1 Ø 230 V	●	●

Flexible Installation Locations

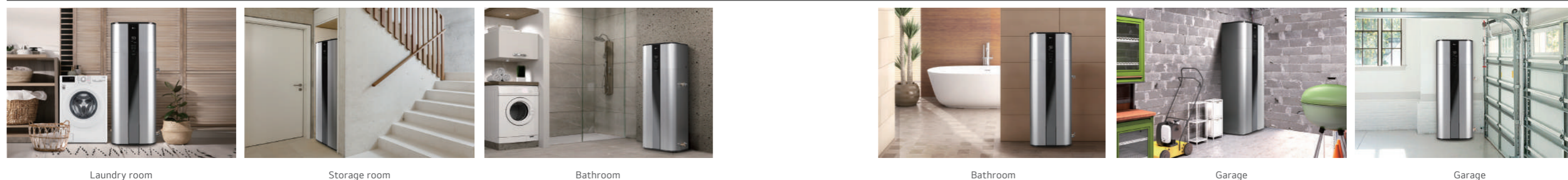

※ Actual product appearance may differ from the above simulated scene.

PRE-SALES / ENGINEERING TOOLS

Pre-sales/Engineering Tools

LG provides a variety of software to support THERMA V for all customers including designers, installers, and end users.

1. LATS THERMA V



[Browse now](#)

LATS THERMA V is a web based simulation tool that enables to choose the optimal THERMA V model from various capacity range and simulates its energy cost comparing to other heating solutions. Furthermore, customer is easily able to simulate payback compared to a conventional system such as a gas boiler, electric boiler by using LATS THERMA V.



There are 3 types project in LATS THERMA V WEB.

1. Model Selection : Select suitable model based on the design conditions you input.

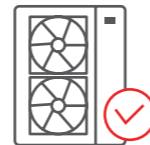

2. Diagram : Generate piping / wiring diagrams in DWG format based on the design conditions and other selected applications.



3. Sound Simulation : Provide noise simulation results according to distance from house.



2. LG Energy Lab



[Browse now](#)

LG Energy Lab online is a web version tool that can print energy labels. It is easy to use because it is composed of a user-friendly UI, and provides additional functions such as contact function and project management function.

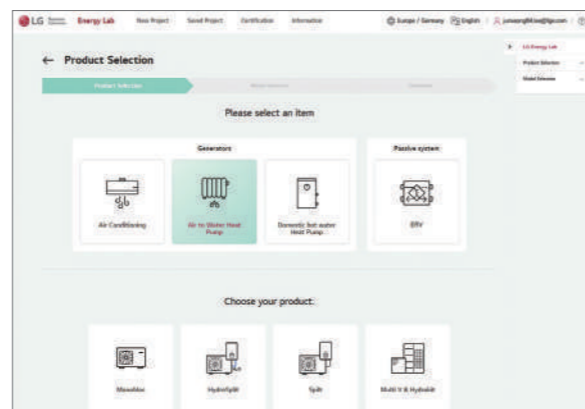

3. LGMV

LGMV is a useful engineering tool that monitors THERMA V's real-time refrigerant and water cycle. It assists installers with effective and efficient start-up and commissioning after the THERMA V installation. LGMV enables service/field engineers to detect the errors and troubleshooting for fast and reliable problem solving.

* LGMV is available on the LG partner portal.

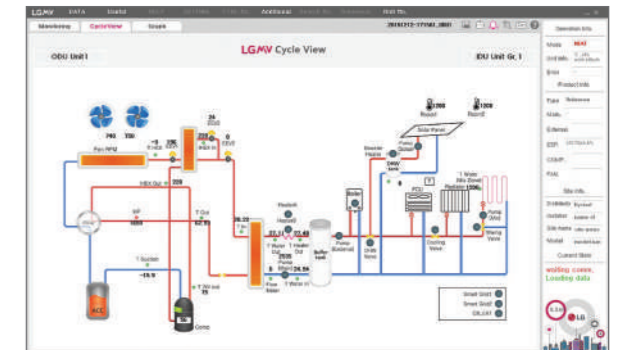

4. LG THERMA V Selector

The LG THERMA V Selector is a mobile application for designers, installers and end users, which provides various real-life simulations. An energy simulation can quickly indicate energy consumption and cost as well as CO₂ emission values that can be vastly reduced from conventional heating systems using minimal input values.

With both model selection and energy simulation tools, quick and accurate selection is made possible with detailed input values such as desired system configuration, required heating and Domestic Hot Water (DHW) load, which will calculate payback, result in a faster energy simulation and generate cost comparisons. Sound level can also be calculated through simulations based on the installation environment.

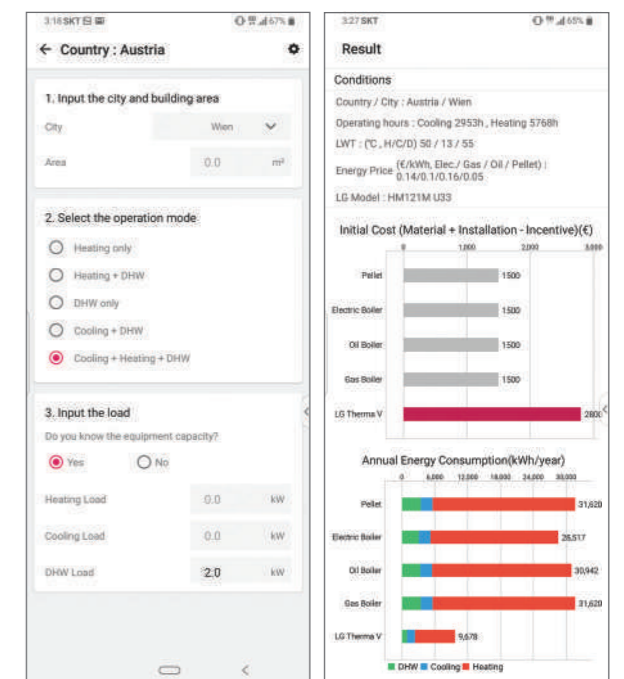

ThinQ SEAMLESS CONNECTIVITY

Smart Control, Smarter Life

LG ThinQ, a smart phone app, allows users to monitor and manage compatible LG products remotely, which means they can set the temperature and regulate the use of their THERMA V anytime and anywhere.

In most EU countries, LG ThinQ technology also works with Google Assistant, letting users control their THERMA V with voice commands.



Mandatory accessory: PWFMD200 (LG Wi-Fi Modem) / PWYREW000 (10 m extension connect cable in between THERMA V indoor and LG Wi-Fi Modem) could be required depending on installation conditions.

- * Search "LG ThinQ" on Google market or App store, then download the app.
- * Google assistant voice control may be restricted in use and language in some countries.
- * Google and Google Home are trademarks of Google LLC.
- * Voice-enabled smart speaker device is not included.

How to install the LG ThinQ app

Search and install for the LG ThinQ application from the Google Play or Apple App Store on a smart phone.

For Android users



Download now

For iOS users



Download now

How to connect THERMA V to the LG ThinQ app

In the video below, see how to install Wi-Fi modem and connect THERMA V and ThinQ.

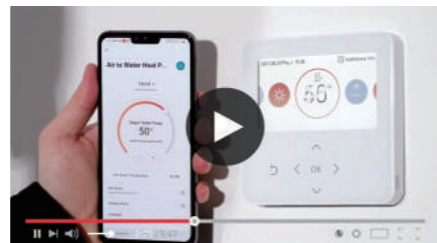

Watch now



Connect and control from anywhere, anytime

LG ThinQ allows end users to easily control their heating system in away they have never done before. Let them experience smart control of THERMA V with just the tap of a button. Even when outside, they can operate the THERMA V remotely.



Simple control with voice assistant

Tell THERMA V exactly what is needed. Say, "Turn on/off the THERMA V" and the AI speaker will listen and turn on/off the THERMA V.

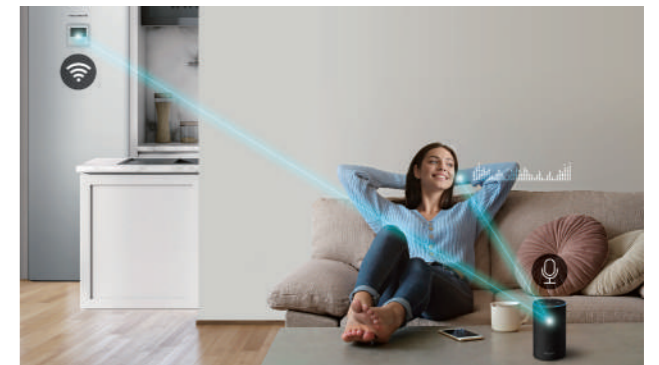

Efficient energy monitoring

The LG ThinQ app continuously monitors THERMA V. Whether it's everyday maintenance or something else, the app allows you to easily monitor energy usage.

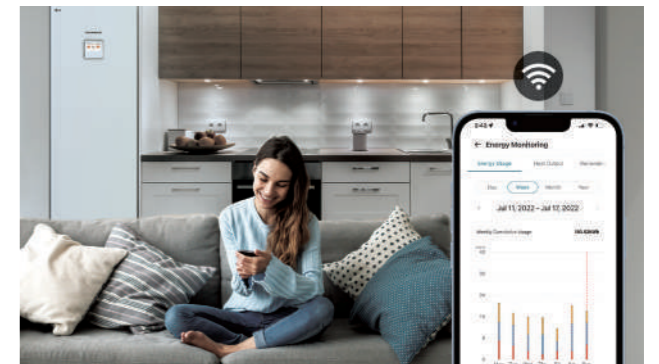

ThinQ mobile app

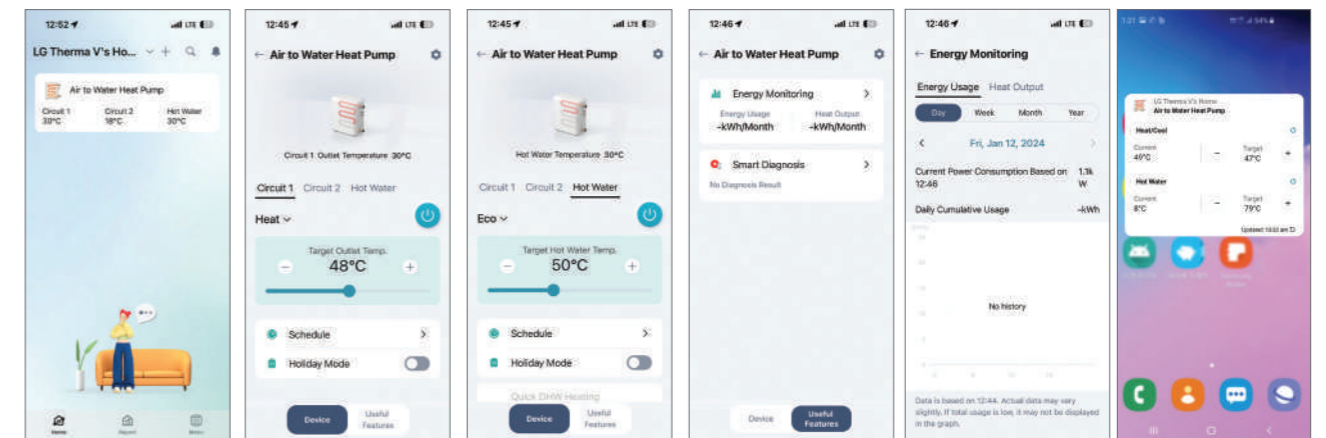

Home screen Space heating / Cooling control Hot water control Useful features Energy monitoring Widget on home screen (Android)

This image is intended to help you understand, and there may be some differences in actual use. * Control via widgets is only possible with the Android app.

LG BECON CLOUD SERVICE

for THERMA V™



What is LG BECON Cloud Service?

LG BECON cloud service is a cloud-based service that remotely monitors a customer's heating system via PC, tablet or mobile anytime, anywhere. The operation status of the heat pump can be monitored at a glance as well as the past operation history. In the event of an issue, the cause can be identified in advance and the repair can be completed during a one-time visit. For more details and service contract, please contact your LG regional service contact.

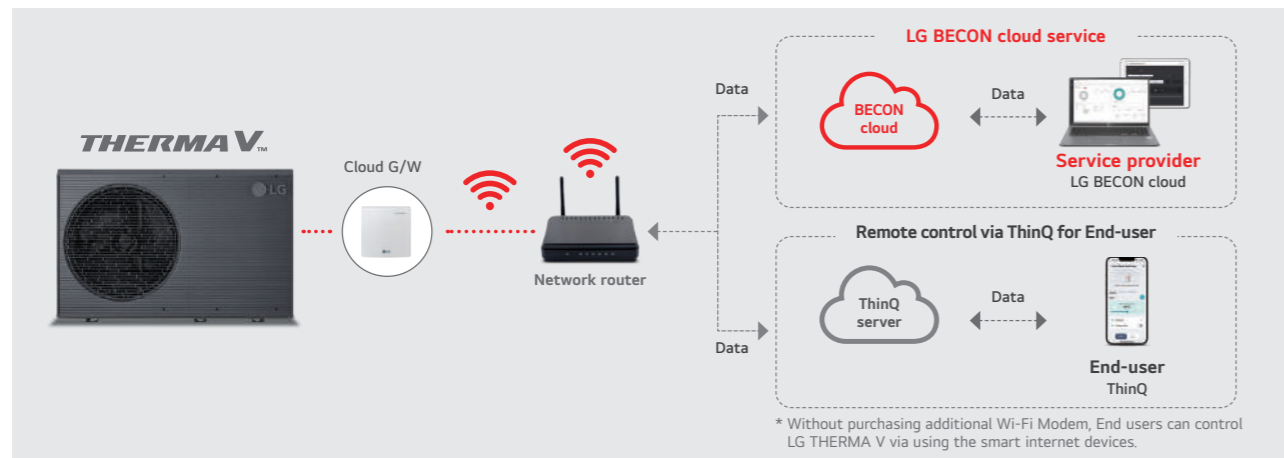

* THERMA V, excluding R290 Monobloc, requires PI485 G/W installation between the Cloud G/W and the outdoor unit.

Target Customer and Benefits

Service partners / Installers

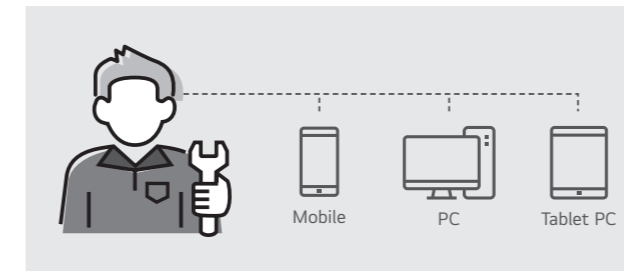

✓ Save time and cost

- One time visit with right parts
- No need pre-visit for diagnosis

✓ Quality of service

- Better service to end users with accurate diagnosis and fast repair

✓ Increased business opportunity

- Combine product + service offer
- Make more installation / repairs

End-users

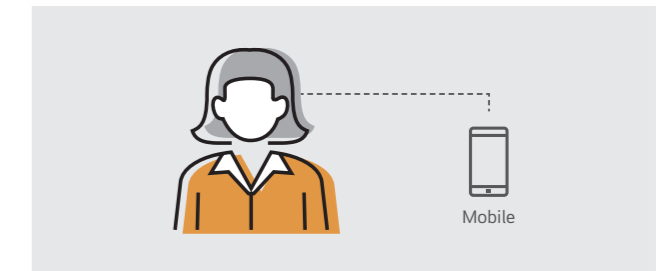

✓ Enjoy peace of mind

- Be serviced at once or faster
- Be confident that immediate and quality of service will be provided in case of an error

✓ Less constraints

- No need to be at home for first diagnosis
- Monitor the operation status and control the system remotely

Key Features



Management at a glance

- Monitoring status of customers
- Interactive map view or list view



Energy monitoring

- Providing warning if energy usage is excessively high
- Display estimated power consumption by self-calculation



Monitoring with visualized schematic

- Examining the operating state of the heat pump
- Schematic view or table view
- Cycle monitoring, sensor and actuator monitoring
- Current status and historical data



Operation and error history

- Providing operation data and error history to quickly identify the issue
- Operation history, error history, setting history, etc



Remote control via cloud

- Preventing unnecessary site visit caused by simple operation mistake
- Operation mode (heating / cooling / DHW), target temperature
- Emergency operation, low noise operation, quick DHW operation



Error notification by e-mail

- Providing an e-mail notification automatically when an error occurs
- Possible to identify immediately and take a fast action

LG BECON CLOUD SERVICE

for THERMA V™

Why LG BECON cloud Service?

Quick service response time

Saving time and cost thanks to remote diagnosis of operation cycle without access to product.

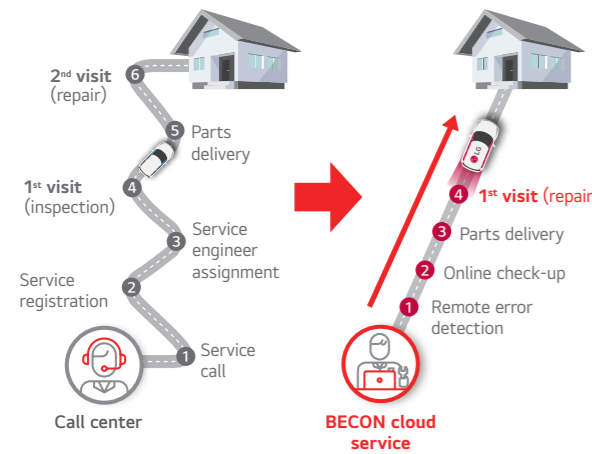

Accurate diagnosis

Accurate diagnosis for cause of failure can be done by utilizing the error code and cycle data when an actual failure occurs.

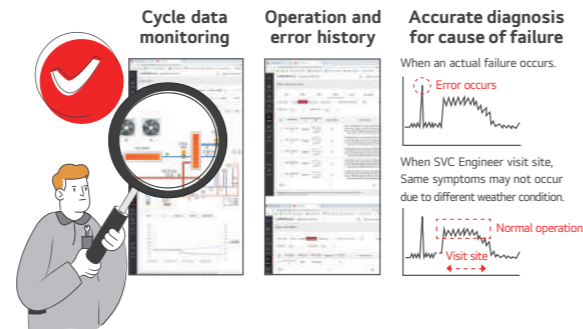

Remote device control

With single account, maintenance service provider (or installer) can control their customer's sites remotely. As a result, site visit is not needed for minor issues, such as adjusting temperature or mode.

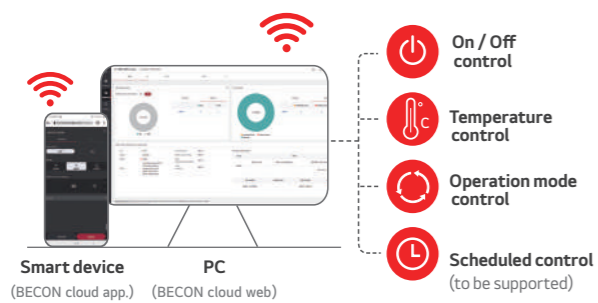

Energy monitoring

Power consumption based on self-calculation is recorded and displayed. Maintenance service provider (or installer) can provide warning if energy usage is excessively high.

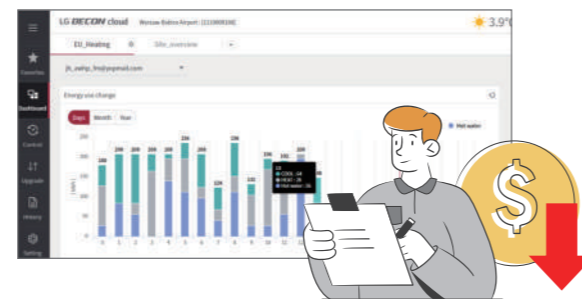

Error notification by e-mail

Providing an e-mail notification automatically when an error occurs, making it possible for maintenance service provider (or installer) to immediately identify and quickly react.

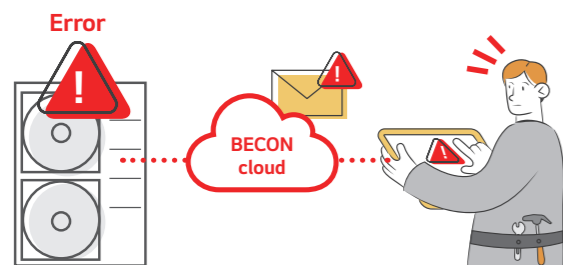

ThinQ for end-users

Without purchasing additional Wi-Fi Modem, end-users can control LG THERMA V via using smart internet devices.

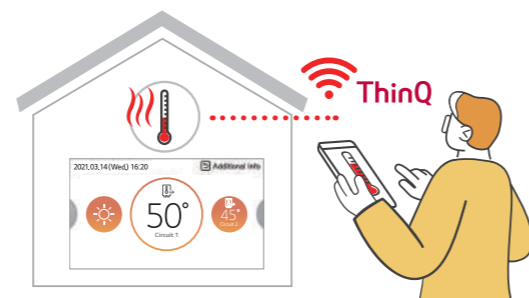

Requirements



Compatible THERMA V ¹⁾	Required accessory	Network router
R290 Monobloc R32 Monobloc S R32 Split Hydro Unit R32 Split Combi Unit R32 Hydrosplit Hydro Unit	Cloud gateway (PWFMD200) PI485 gateway (PP485A00T) ¹⁾	Wireless or wired LAN
LG BECON cloud service contract	Supported device / software	Supported language ²⁾
Authority (ID and PW) to use LG platform (LG BECON cloud service)	PC, Tablet, Mobile PC or Mobile web browser, Mobile app. (Android / iOS)	English, Spanish, Italian, German, Polish, Greek

1) In the case of R290 Monobloc, PI485 G/W is built-in, so there is no need to purchase it separately.
2) More languages will be supported sequentially. The schedule for service availability may vary by country.

Interface Screen

Dashboard

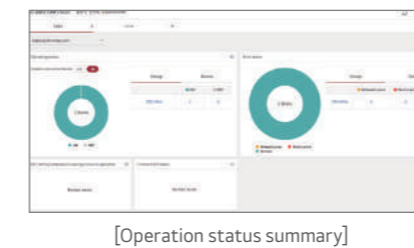

Site

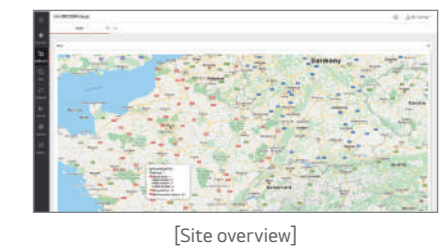
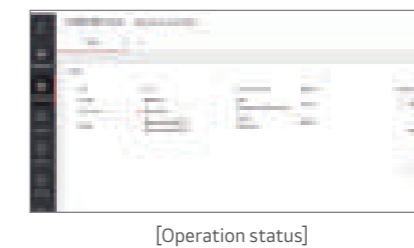

Control

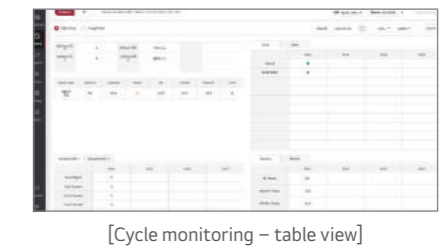
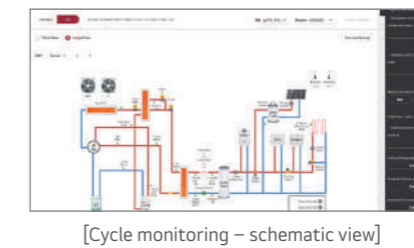
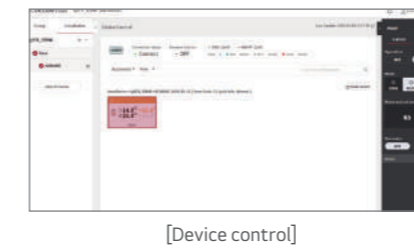

History

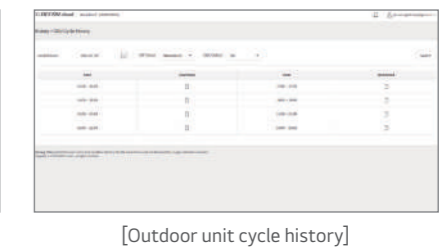
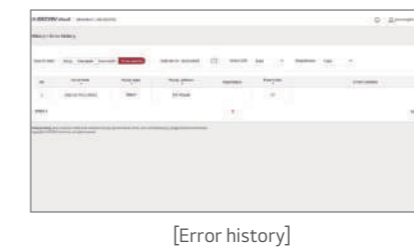

LG SMART HOME ENERGY PACKAGE



Power your home the smart way and save the energy bill

Your connected energy solution at a glance. The LG smart home energy package consists of LG's Energy Storage System (ESS) and the Air-to-Water Heat Pump (AWHP or ASHP), a system that's been expertly designed with compatibility in mind. With LG, you are able to minimize the energy cost and one step closer to the ultimate smart home.

Power your home the smart way and save on the energy bill

The connected energy solution at a glance. The LG smart home energy package consists of LG's Energy Storage System (ESS) and the Air-to-Water Heat Pump (AWHP or ASHP), a system that's been expertly designed with compatibility in mind. With LG, you are able to minimize the energy cost and one step closer to the ultimate smart home.

Conventional Products

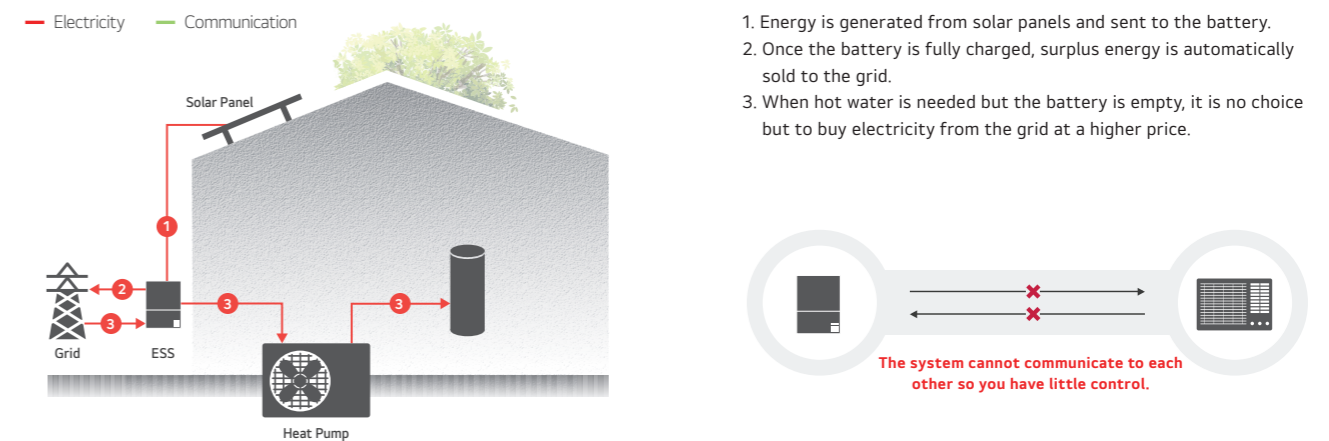

LG Energy Package

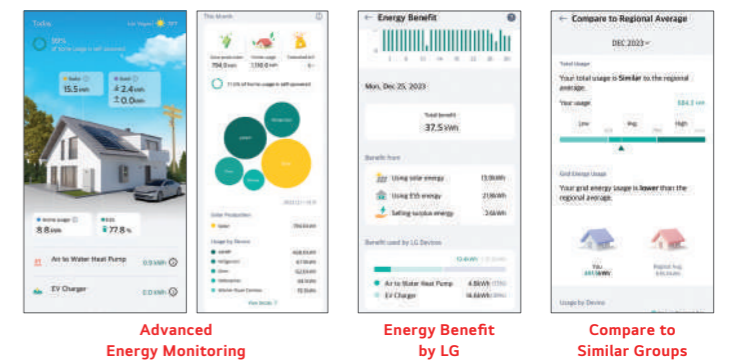
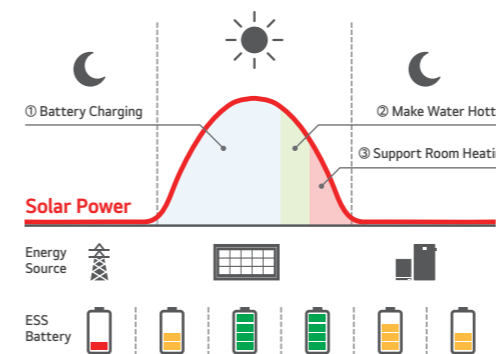
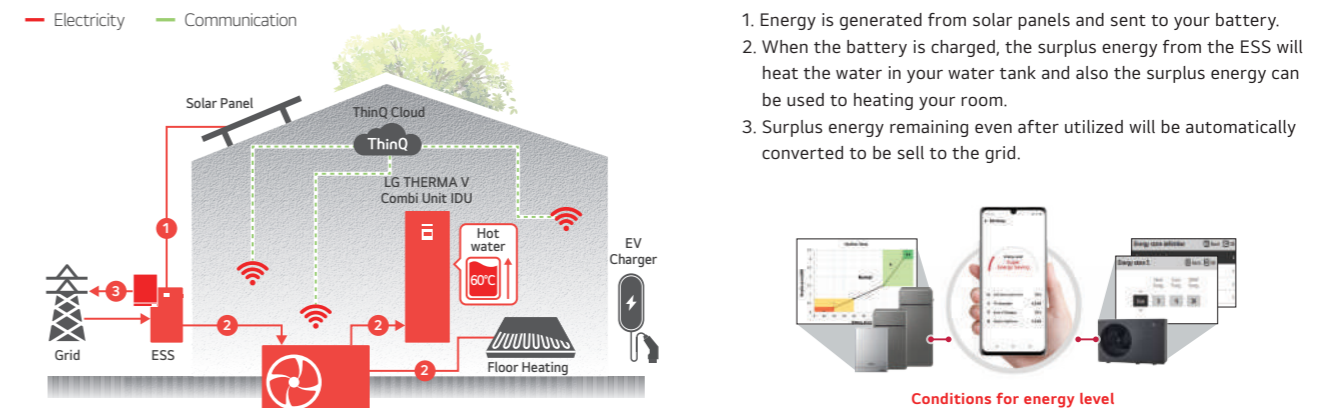

LG ESS RESIDENTIAL LINE UP HOME SERIES

- LG ESS Home 8 / 10
 - D008KE1N211
 - D010KE1N211
- LG HBC Battery 11H / 15H
 - BUEL011HBC1
 - BUEL015HBC1



- LG ESS Home 4.6
 - RA460K07A00 (4.6 kW / 7.12 kWh)
 - RA460K11A00 (4.6 kW / 10.68 kWh)
- LG ESS Home 6
 - RA600K07A00 (6 kW / 7.12 kWh)
 - RA600K11A00 (6 kW / 10.68 kWh)



Type	Three phase DC		Single phase DC	
	Home 8	Home 10	Home 4.6	Home 6
DC input	12 kW	13.5 kW	6.9 kW	9.0 kW
AC Power	8 kW	10 kW	4.6 kW	6.0 kW
Battery Usable Capacity	10.7 / 14.2 kWh		7.1 / 10.7 kWh	
Style	Multiple units (Battery separated)		Single unit (All in one)	
Usable MPP Voltage Range	150 - 800 V		150 - 510 V	
Number of MPPT	3		2	
Degree of Protection	IP21			
Warranty	10 years			
Energy Meter	ABB (B21-112-100, B21-212-100, B21-312-100)			



#CareForWhereYouLive



Watch now ▶

THERMA V™



THEIRMA V™ PRODUCTS

MONOBLOC

- NEW** R290 MONOBLOC 046
- R32 MONOBLOC S 058

HYDROSPLIT

- R32 HYDROSPLIT HYDRO UNIT 076
- R32 HYDROSPLIT COMBI UNIT 088

SPLIT

- R32 SPLIT HYDRO UNIT 100
- R32 SPLIT COMBI UNIT 116
- R410A SPLIT HYDRO UNIT 138

HOT WATER HEAT PUMP

- HOT WATER HEAT PUMP 148



THERMA V™ R290 Monobloc



A Heat Pump
for a Sustainable
Future



What is R290 Monobloc

The new R290 Monobloc is a super-quiet, future-conscious heat pump that uses the R290 refrigerant which has lower GWP of only three.

Refined grey design allows it to seamlessly harmonize with a diverse range of home and building exteriors and thanks to its low noise level, you don't have to worry about finding an installation location that won't disturb your neighbors.

The LG THERMA V R290 Monobloc is available in three different combinations (Control Unit, Hydro Unit or Combi Unit*) depending on the customers' needs.

* The Combi Unit are under development, those will be launched within this year.

Product Range

Phase	Capacity (kW)	Indoor Unit		Outdoor Unit
1 Ø	12	HN1616HC NKO	PHCSO	HM121HF UB60
	14			HM141HF UB60
	16			HM161HF UB60
3 Ø	9	HN1639HC NKO	PHCSO	HM093HFX UB60
	12			HM123HF UB60
	14			HM143HF UB60
	16			HM163HF UB60

Key Features

- Capacity range from 9 to 16 kW for renovation and large new builds
- Natural refrigerant R290 with low GWP (3)
- Refined gray design that adapts to various surroundings
- One of the quietest models on the market (49 dB(A) for 12 kW models)
- Maximum flow temperature up to 75°C
- Operation range down to -28°C
- Customized combinations of Control Unit, Hydro Unit, and Combi Unit

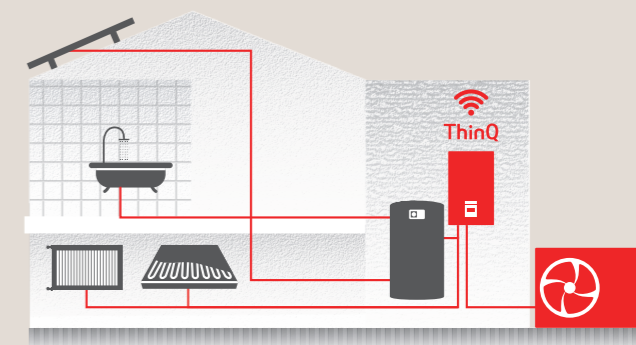

Excellent performance & efficiency

- R290: Natural refrigerant with GWP 3
- Adaptive Injection
- Wide operation range
- Quiet operation
- Black Fin heat exchanger
- Solar thermal
- Energy state
- Modbus connectivity

User convenience

- harmonic design with surroundings
- Intuitive interface
- LG ThinQ
- 2nd circuit
- Various control options
- Seasonal auto mode
- 3rd party boiler
- Energy monitoring
- DHW recirculation
- Low noise mode
- Advanced pump control options
- 2 remote control

Easy installation & maintenance

- Monobloc concept
- all-in-one
- LG BECON cloud
- 2-way water piping
- Clip connection

THERMA V™ R290

HIGHLIGHT OF R290 MONOBLOC HYDRO UNIT



Browse now

New Design

European design



- Refined gray design with wavy grille

High reliability

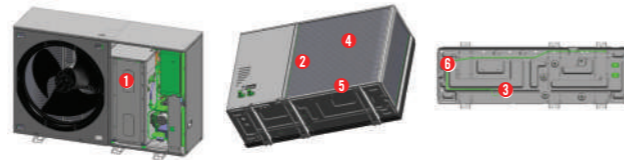

Anti-icing and Deicing technologies for R290 Monobloc

- 1 Defrost operation by dual EEVs & Cycle
- 2 Corrugated fin
- 3 Base pan heating (heater)
- 4 Elimination of side panel and rear grille
- 5 Frost-free for bottom pass of heat exchanger
- 6 Increased quantity for drain holes

High Efficiency Operation

Exceptional efficiency

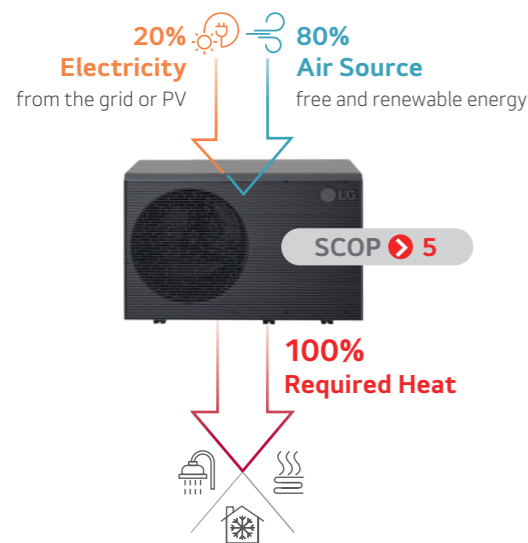

Annual energy cost simulation

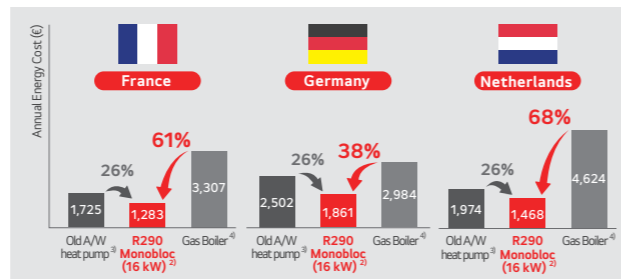

* This simulation result may differ from actual values due to assumptions.
 * Annual energy costs are calculated based on national gas and electricity prices as of June 2023 and may differ from the actual cost paid by customers depending on energy price changes and individual energy use patterns.
 For conventional heat pumps and gas boilers, energy consumption matches LG THERMA V R290 Monobloc 16 kW's heating demand. Specific assumptions include:
 1) considered only space heating for all system (DHW operation is not considered)
 2) average climate, low temperature application (35°C).
 3) SCOP 2.7 to account for a 10-year-old heat pump's performance degradation.
 4) 90% efficiency with a condensing boiler.

Extremely Quiet Operation

Heats home in hushed tones

R290 Monobloc	9 kW & 12 kW	14 kW	16 kW
Sound power level ¹⁾ (heating / rated)	49	51	52
Sound power level ¹⁾ (heating / low noise mode)	48	50	51

1) Sound power level is measured in accordance with EN 12102-1 and ISO 9614.

Ensuring regulatory compliance across all EU markets

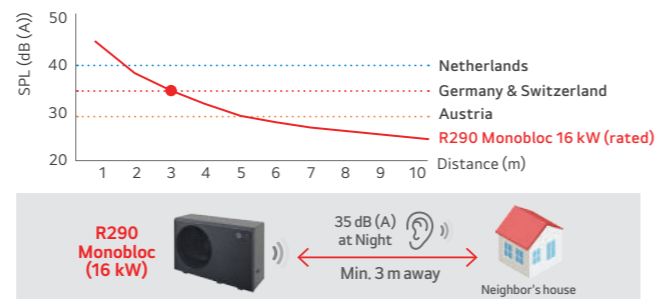

Customers can have peace of mind with no risk of complaints and no additional costs for acoustic enclosures.

Improved Operational Stability

Freezing outside, but toasty inside

The R290 Monobloc can function in external temperatures as low as -28°C. Plus, customers can retain their existing radiators as the system can generate a water flow of up to 75°C, offering a cost-saving advantage.



Freedom of Integration

Customized combinations to meet diverse needs

Since THERMA V R290 Monobloc has hydro components integrated into the outdoor unit, it can be combined with various indoor units to implement applications tailored to customer needs.

Outdoor unit	Indoor unit type	
		Control Unit • Stand-alone concept • Easy integration with 3 rd party equipment
		Hydro Unit • Back-up heater & expansion tank integrated inside the Hydro Unit
		Combi Unit* • DHW tank, electric heater, expansion tank integrated inside the Combi Unit • 200 l stainless steel tank

* The Combi Unit are under development, those will be launched within this year.

Convenience

Easy installation

The two-way piping connection method not only grants greater installation flexibility but also offers distinct advantages when it comes to concealing underground piping for both aesthetic and frost protection purposes.

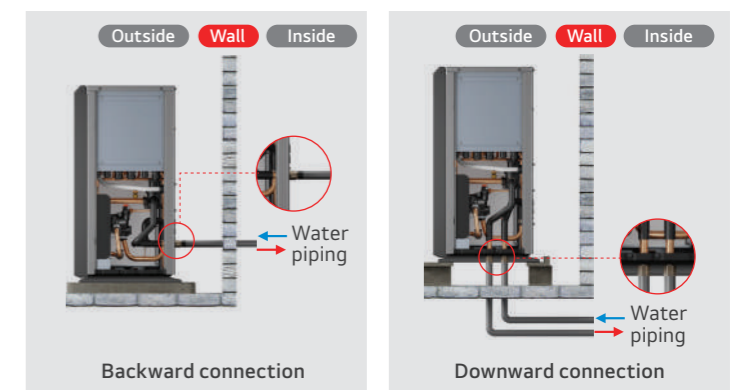

THERMA V™ R290

R290 MONOBLOC HYDRO UNIT

Outdoor unit

HM093HFX UB60
 HM121HF UB60 / HM123HF UB60
 HM141HF UB60 / HM143HF UB60
 HM161HF UB60 / HM163HF UB60

Indoor unit

HN1616HC NK0
 HN1639HC NK0

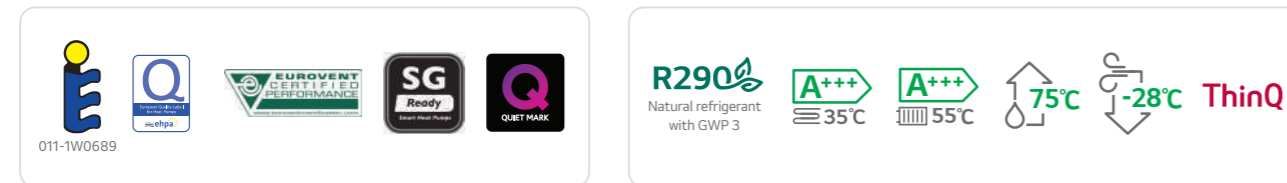

Key Components

Outdoor Unit

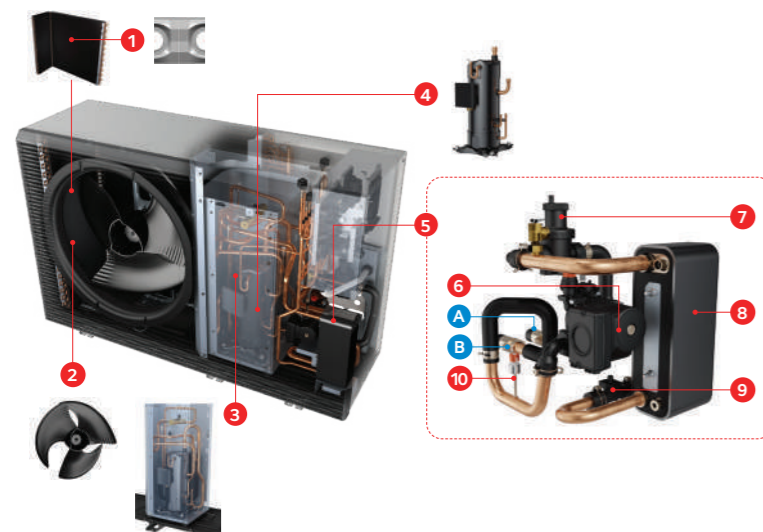

Components

- 1 Black Fin heat exchanger (air / ref.)
- 2 New biomimetic fan
- 3 Dual sound shield
- 4 R290 scroll compressor
- 5 Hydronic components assembly
- 6 Water pump
- 7 Deaerator
- 8 Plate heat exchanger (ref / water)
- 9 Flow sensor
- 10 Pressure sensor

Connections

- A Leaving water pipe (male PT 1")
- B Entering water pipe (male PT 1")

Indoor Unit (Hydro Unit)

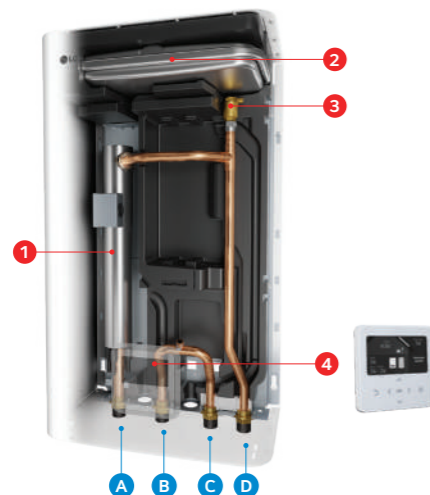

Components

- 1 Backup heater (1 Ø: 6 kW / 3 Ø: 9 kW)
- 2 Expansion tank (8 l)
- 3 Air vent valve
- 4 Standard III remote controller¹⁾

1) Temperature control class (ERP class) : V

Connections

- A Heating circuit outlet pipe (male PT 1")
- B Heating circuit inlet pipe (male PT 1")
- C Outlet pipe to outdoor unit (male PT 1")
- D Inlet pipe from outdoor unit (male PT 1")

Product Specification

Efficiency Data		Unit	9 kW (3 Ø)	12 kW (1 Ø) 12 kW (3 Ø)	14 kW (1 Ø) 14 kW (3 Ø)	16 kW (1 Ø) 16 kW (3 Ø)
Seasonal space heating eff. class (35°C / 55°C)	-		A+++ / A++	A+++ / A+++	A+++ / A+++	A+++ / A+++
Seasonal space heating efficiency (η _s) (35°C / 55°C)	%		206 / 147	215 / 156	212 / 155	201 / 154
SCOP (35°C / 55°C)	-		5.23 / 3.75	5.45 / 3.97	5.38 / 3.96	5.11 / 3.92
Sound power level (outdoor unit)	Rated / low noise mode	dB(A)	49 / 48	49 / 48	51 / 50	52 / 51
Sound pressure level at 5m (outdoor unit)	Rated / low noise mode	dB(A)	27 / 26	27 / 26	29 / 28	30 / 29
Sound power level (indoor unit)	Rated	dB(A)	39			
Sound pressure level at 1m (indoor unit)	Rated	dB(A)	31			

Nominal Capacity and COP/EER

Air / water	Heating capacity / COP	kW / -	9.00 / 4.90	12.00 / 4.70	14.00 / 4.50	16.00 / 4.30
Air +7°C / water +35°C	Heating capacity / COP	kW / -	9.00 / 3.88	12.00 / 3.72	14.00 / 3.61	14.50 / 3.49
Air +2°C / water +35°C	Heating capacity / COP	kW / -	8.90 / 3.44	11.80 / 3.27	13.00 / 3.21	13.80 / 3.17
Air -7°C / water +35°C	Heating capacity / COP	kW / -	9.00 / 3.20	10.00 / 3.10	11.00 / 3.25	12.00 / 3.30
Air +7°C / water +55°C	Heating capacity / COP	kW / -	7.00 / 2.43	9.30 / 2.32	10.30 / 2.28	10.90 / 2.26
Air -7°C / water +55°C	Heating capacity / COP	kW / -	9.00 / 3.90	11.50 / 3.78	12.00 / 3.70	12.50 / 3.70
Air +35°C / water +18°C	Cooling capacity / EER	kW / -	9.00 / 3.24	10.50 / 3.12	12.00 / 2.99	12.50 / 2.95
Air +35°C / water +7°C	Cooling capacity / EER	kW / -				

Outdoor Units		Unit	HM093HFX UB60	HM121HF UB60 HM123HF UB60	HM141HF UB60 HM143HF UB60	HM161HF UB60 HM163HF UB60
Operation range (outdoor air temperature)	Heating & DHW (Min. - Max.)	°C	-28 - 35			
	Cooling (Min. - Max.)	°C	5 - 48			
Refrigerant	Type	-	R290			
	GWP	-	3			
	Precharged amount	g	1,200			
Piping connections (water)	Inlet / outlet diameter	inch	Male PT 1" according to ISO 7-1 (tapered pipe threads)			
Dimension	H x W x D	mm	1,019 x 1,560 x 520			
Weight	Empty	kg	181.0			
Exterior	Color of chassis / RAL code	-	Dawn gray / RAL 7037			
	Color of front grille / RAL code	-	Dark dawn gray / RAL 7012			
Power supply	Voltage, phase, frequency	V, Ø, Hz	380 - 415, 3, 50	220 - 240, 1, 50 / 380 - 415, 3, 50		
	Standby power consumption	W	10			
	Recommended circuit breaker	A	16	1 Ø: 25 / 3 Ø: 16		

Indoor Units		Unit	HN1616HC NK0 HN1639HC NK0
Operation range (leaving water temperature)	Heating (Min. - Max.)	°C	15 - 75
	Cooling (Min. - Max.)	°C	5 - 27
	DHW (Min. - Max.)	°C	15 - 80
Expansion vessel (heating circuit)	Volume	l	8
	Capacity combination	kW	3.0 + 3.0 / 3.0 + 3.0 + 3.0
Backup heater	Heating steps	Steps	2
	Power supply	V, Ø, Hz	220 - 240, 1, 50 / 380 - 415, 3, 50
	Rated running current	A	26 / 13
	Heating circuit outlet pipe	inch	
Piping connections (water)	Heating circuit inlet pipe	inch	
	Outlet pipe to outdoor unit	inch	
	Inlet pipe from outdoor unit	inch	
Dimension	H x W x D	mm	850 x 490 x 315
Weight	Empty	kg	30.0 / 31.0
Exterior	Color / RAL code	-	Noble white / RAL 9016
Power supply	Voltage, phase, frequency	V, Ø, Hz	220 - 240, 1, 50
	Recommended circuit breaker	A	10

Note

1. Due to our policy of innovation, some specifications may be changed without notification.
2. Wiring cable size must comply with the applicable local and national codes. Especially the power cable and circuit breaker should be selected in accordance with that.
3. Sound power level is measured on the rated condition in accordance with ISO 9614 standard. Sound pressure level is not a value declared on Eurovent Program and is converted from sound power level based on a tonality penalty of 0 dB and installation in free-field. The directivity index (Q) is assumed as 2. Therefore, these values can be increased owing to ambient conditions during operation. Rated sound power level is in accordance with EN12102-1 under condition of EN14825.
4. Performances are in accordance with EN14511 and reflect ErP testing conditions. Above gives the declared values at rated conditions according to ErP regulation.
5. This product contains fluorinated greenhouse gases.
6. All installation sites must be equipped with an earth leakage circuit breaker (ELCB).
7. DHW 65 - 80°C Operating is available only when the booster heater is operating.

THERMA V™ R290

R290 MONOBLOC HYDRO UNIT

Drawings

HM093HFX UB60
 HM121HF UB60 / HM123HF UB60
 HM141HF UB60 / HM143HF UB60
 HM161HF UB60 / HM163HF UB60

[Unit: mm]

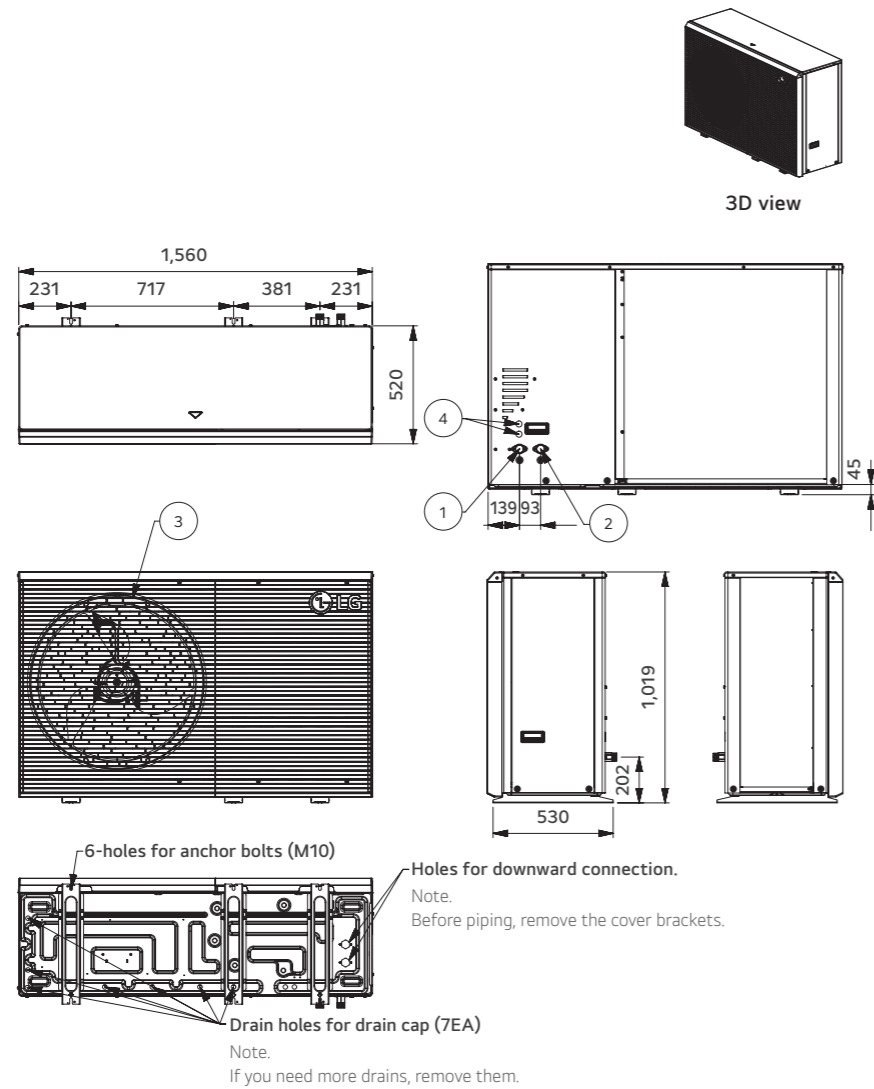

No.	Part name	Description
1	Leaving water pipe	Male PT 1" according to ISO 7-1 (tapered pipe threads)
2	Entering water pipe	Male PT 1" according to ISO 7-1 (tapered pipe threads)
3	Air discharge grille	-
4	Access to electrical terminals	Power, Communication

HN1616HC NK0 / HN1639HC NK0

[Unit: mm]

External

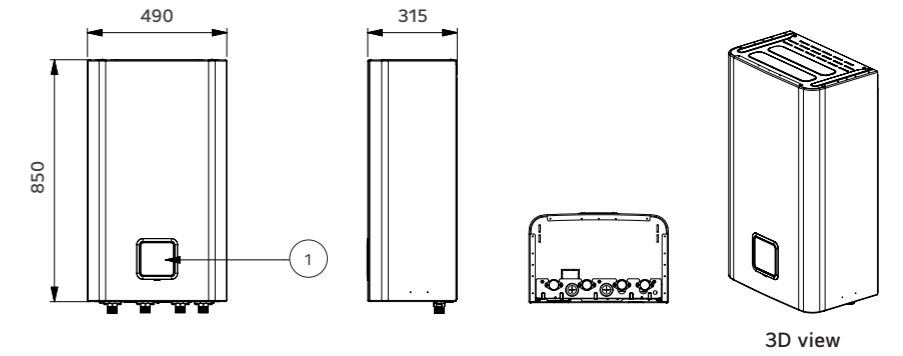

No.	Part name	Description
1	Control panel	Built-in remote controller

Internal

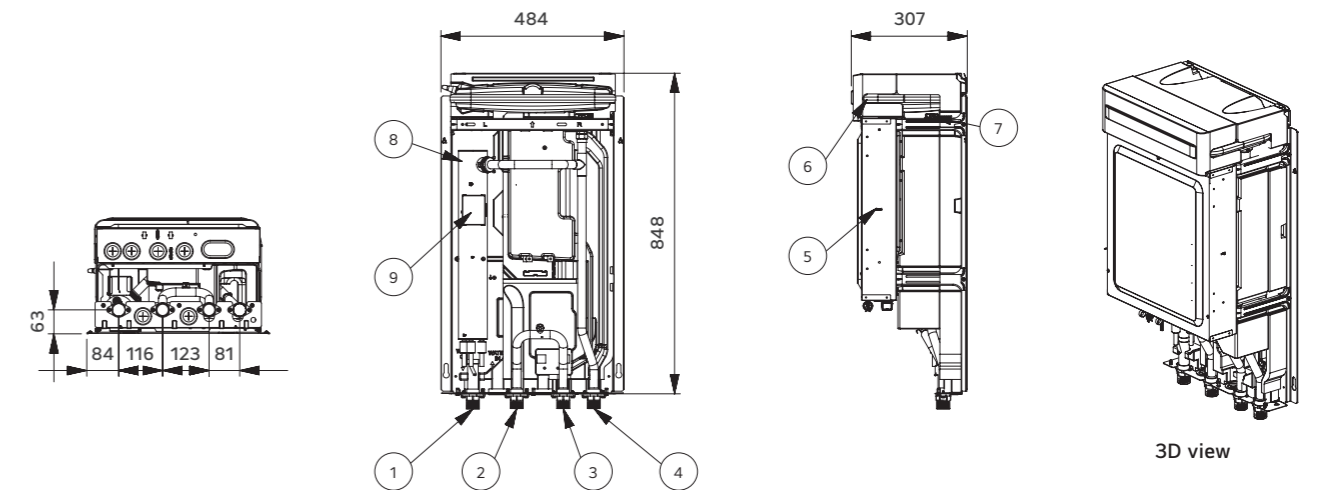

No.	Part name	Description
1	Leaving water pipe (heat load)	Male PT 1" according to ISO 7-1 (tapered pipe threads)
2	Entering water pipe (heat load)	Male PT 1" according to ISO 7-1 (tapered pipe threads)
3	Leaving water pipe (ODU)	Male PT 1" according to ISO 7-1 (tapered pipe threads)
4	Entering water pipe (ODU)	Male PT 1" according to ISO 7-1 (tapered pipe threads)
5	Control box	PCB and terminal blocks
6	Expansion tank	Absorbing volume change of heated water
7	Air vent	Air purging when charging water
8	Backup heater	Capacity: 1 Ø 6kW, 3 Ø 9kW
9	Terminal switch	Cut-off power input to backup heater at 90°C (manual return 55°C)

THERMA V™ R290

R290 MONOBLOC CONTROL UNIT

Outdoor unit

HM093HFX UB60
 HM121HF UB60 / HM123HF UB60
 HM141HF UB60 / HM143HF UB60
 HM161HF UB60 / HM163HF UB60

Indoor unit

PHCS0

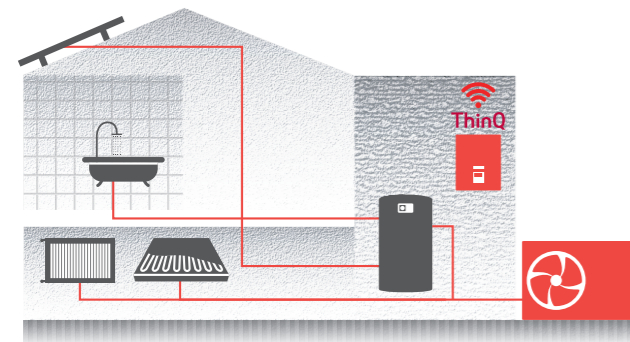

Key features

- Stand-alone concept
- Light weight and compact size fits in small spaces
- Simple installation by minimizing piping and wiring work
- Easy integration with 3rd party equipment because of less cabling

Indoor Units		Unit	PHCS0
Operation range (leaving water temperature)	Heating (Min. - Max.)	°C	15 - 75
	Cooling (Min. - Max.)	°C	5 - 27
	DHW (Min. - Max.)	°C	15 - 80
Dimension	H x W x D	mm	490 x 420 x 141
Weight	Empty	kg	6.7
Exterior	Color / RAL code	-	Essence white / RAL 9003
Power supply	Voltage, phase, frequency	V, Ø, Hz	220-240, 1, 50
	Recommended circuit breaker	A	10

THERMA V™ R290

R290 MONOBLOC COMBI UNIT

PRELIMINARY INTRODUCTION

Outdoor unit

HM093HFX UB60
 HM121HF UB60 / HM123HF UB60
 HM141HF UB60 / HM143HF UB60
 HM161HF UB60 / HM163HF UB60

Indoor unit

HN1616HY NK0
 HN1636HY NK0

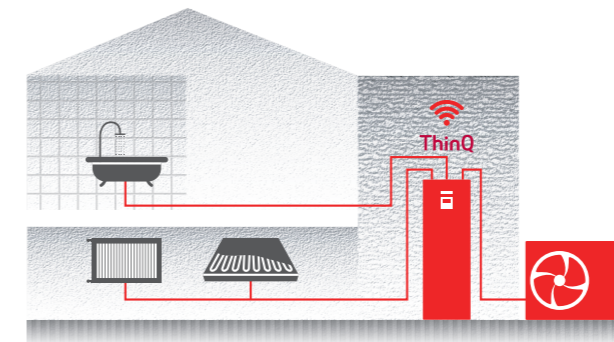

Key features

- All-in-one Combi Unit with integrated hot water cylinder
- Saves space in the technical room with a small footprint
- Installation time reduced with pre-installed components
- Harmonized with other household appliances for a cohesive exterior

Indoor Units		Unit	HN1616HY NK0 HN1636HY NK0
Operation range (leaving water temperature)	Heating (Min. - Max.)	°C	15 - 75
	Cooling (Min. - Max.)	°C	5 - 27
	DHW (Min. - Max.)	°C	15 - 80
Domestic hot water tank	Volume	ℓ	200
	Tank material	-	Duplex stainless steel
	Standby losses	W	60
Expansion vessel (heating circuit)	Volume	ℓ	8
Electric heater	Capacity combination	kW	1 Ø: 3.0, 6.0 / 3 Ø: 9.0
	Power supply	V, Ø, Hz	220-240, 1, 50 / 380-415, 3, 50
Piping connections (water)	Inlet / outlet diameter for connection to outdoor unit	inch	Female G1" according to ISO228-1 (parallel pipe threads)
	Inlet / outlet diameter for space heating	inch	
	Inlet / outlet diameter for DHW	inch	
	Recirculation	inch	
Dimension	H x W x D	mm	1,750 x 600 x 660 (expected, subject to change in the future)
Weight	Empty	kg	113.0 (expected, subject to change in the future)
Exterior	Color / RAL code	-	White / RAL 9016

* The Combi Unit are under development, those will be launched within this year. Therefore, this specification is preliminary and it may be changed.

THERMA V™

R32 Monobloc S

Silence and Supreme



What is R32 Monobloc S

The THERMA V R32 Monobloc S is a ready-to-install, plug and play heat pump without an indoor unit. As implied by "silence" and "supreme," it boasts reduced noise level and best performance in the THERMA V R32 series. With its unique design, it requires only water piping connections, eliminating the need for additional refrigerant piping work. This not only simplifies installation but also ensures a space-efficient solution suitable for both new builds and renovations.

Product Range

Capacity (kW)	Unit		Appearance
	1 Ø	3 Ø	
5	HM051MR U44	-	
7	HM071MR U44	-	
9	HM091MR U44	HM093MR U44	
12	HM121MR U34	HM123MR U34	
14	HM141MR U34	HM143MR U34	
16	HM161MR U34	HM163MR U34	



Key Features

- Capacity range from 5 to 16 kW for new build and renovation
- R32 refrigerant with reduced Global Warming Potential (GWP)
- No need for F-gas license and simple installation due to no refrigerant piping work
- Low noise level for high installation flexibility
- Maximum flow temperature up to 65°C
- Operation range down to -25°C
- Standalone heat pump allowing easy installation

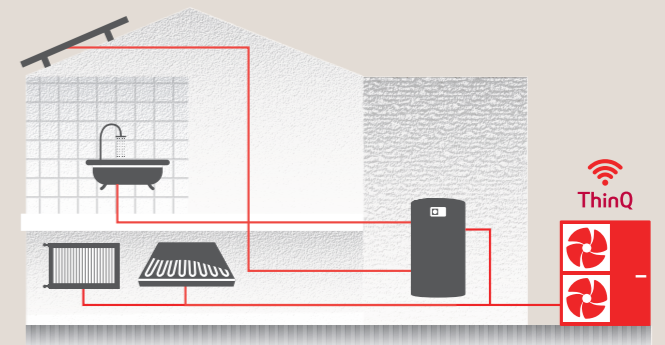

Excellent performance & efficiency

- R32 refrigerant
- R1 Compressor
- Flash gas injection
- Wide operation range
- Black Fin heat exchanger
- Solar thermal
- Energy state
- Modbus connectivity

User convenience

- Intuitive interface
- LG ThinQ
- 2nd circuit
- Various control options
- Seasonal auto mode
- 3rd party boiler
- Energy monitoring
- DHW recirculation
- Low noise mode
- Advanced pump control options
- 2 remote control

Easy installation & maintenance

- Monobloc concept
- all-in-one
- LG BECON cloud
- Clip connection

THERMA V™ R32
HIGHLIGHT OF **R32 MONOBLOC S**



Browse now



Ready-to-install and Space Saving Solution

- Integrated hydronic components in the package
- Easier and quicker installation without refrigerant piping work
- The best solution, when interior space is limited



Low Noise Level Allowing Installation Flexibility

- Designed to reach lower noise levels in order to meet homeowner expectations in urban areas
- Noise reduction technology such as encapsulated compressor and vibration-decoupling to ensure a quieter and more comfortable experience
- Quiet Mark certified*



*Certified products are HM051MR U44 / HM071MR U44 / HM091MR U44 / HM093MR U44 / HM121MR U34 / HM123MR U34. This certification is valid for UK & EU territories only.



Monobloc Concept

R32 Monobloc S is an all-in one concept, with its reduced weight allowing quicker and easier installations.

- Additional hydronic components are included in the package
- Easier and quicker installation without refrigerant piping work
- The best solution when space heating only is needed

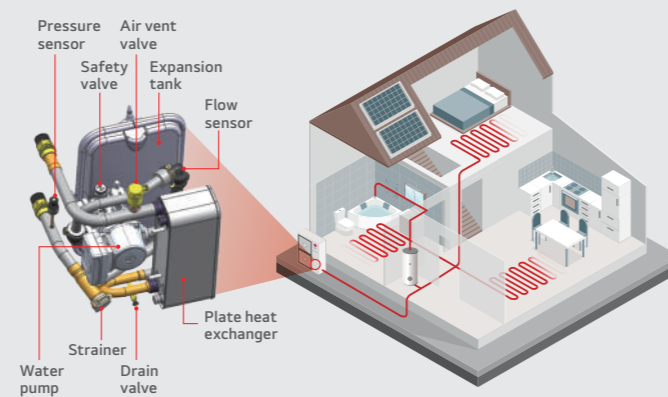

Remarkable Heating Performance even in Cold Weather

- 100 % heating capacity at -15°C ambient temp. (@LWT 35 °C, except for 16 kW model)
- Longer continuous heating periods with reduced defrost operation time and extended intervals



THERMA V™ R32 MONOBLOC S

Outdoor unit
 HM051MR U44
 HM071MR U44
 HM091MR U44
 HM093MR U44

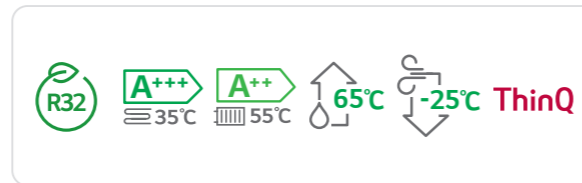
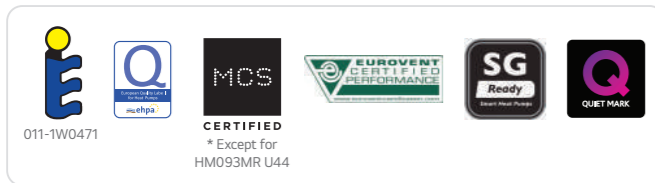

Key Components

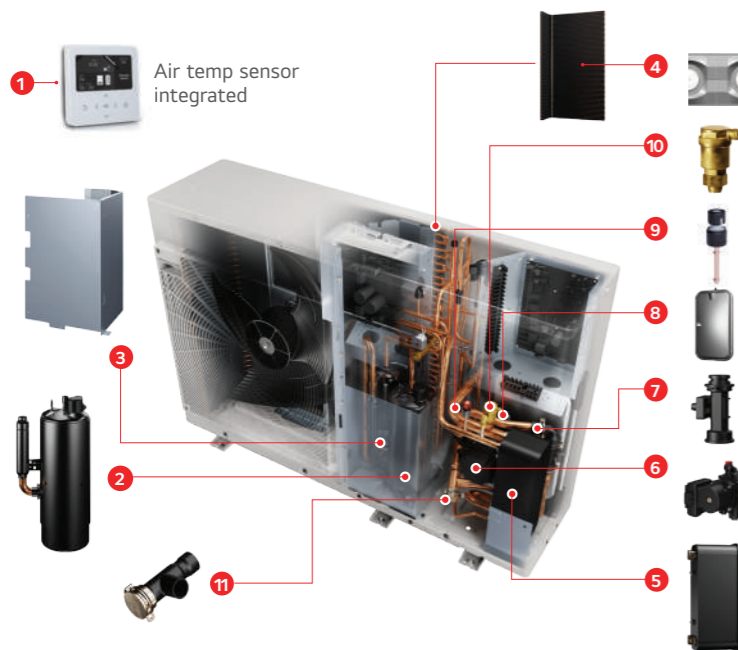

Components

- 1 Standard III remote controller^{1), 2)}
- 2 R1 Compressor
- 3 Compressor noise shield
- 4 Black Fin heat exchanger (ref/air)
- 5 Plate type heat exchanger (ref/water)
- 6 Water pump
- 7 Water flow sensor
- 8 Expansion vessel (8 l)
- 9 Water pressure sensor
- 10 Air vent valve
- 11 Strainer

1) The remote controller is supplied with the product, but it needs to be installed separately.
 2) Temperature control class (ERP class) : V

Product Specification

Efficiency Data		Unit	5 kW (1 Ø)	7 kW (1 Ø)	9 kW (1 Ø) 9 kW (3 Ø)
Seasonal space heating eff. class (35°C / 55°C)	-		A+++ / A++	A+++ / A++	A+++ / A++
Seasonal space heating efficiency (η_s) (35°C / 55°C)	%		175 / 125	176 / 125	179 / 125
SCOP (35°C / 55°C)	-		4.46 / 3.20	4.48 / 3.20	4.55 / 3.20
Sound power level	Rated / low noise mode	dB(A)	57 / 54	57 / 55	
Sound pressure level at 5m	Rated / low noise mode	dB(A)	35 / 32	35 / 33	

Nominal Capacity and COP/EER

Air / water temperature	Heating capacity / COP	Unit	5 kW / 4.70	7.00 / 4.70	9.00 / 4.60
Air +7°C / water +35°C	Heating capacity / COP	kW / -	5.50 / 4.70	7.00 / 4.70	9.00 / 4.60
Air +2°C / water +35°C	Heating capacity / COP	kW / -	4.40 / 3.60	5.60 / 3.55	6.80 / 3.50
Air +7°C / water +55°C	Heating capacity / COP	kW / -	5.50 / 2.70	5.50 / 2.70	5.50 / 2.70
Air +35°C / water +18°C	Cooling capacity / EER	kW / -	5.50 / 4.70	7.00 / 4.70	9.00 / 4.60
Air +35°C / water +7°C	Cooling capacity / EER	kW / -	5.50 / 3.30	7.00 / 3.20	9.00 / 3.10

Outdoor Units		Unit	HM051MR U44	HM071MR U44	HM091MR U44 HM093MR U44
Operation range (outdoor air temperature)	Heating & DHW (Min. - Max.)	°C	-25 ~ 35		
	Cooling (Min. - Max.)	°C	5 ~ 48		
Operation range (leaving water temperature)	Heating (Min. - Max.)	°C	15 ~ 65		
	Cooling (Min. - Max.)	°C	5 ~ 27		
	DHW (Min. - Max.)	°C	15 ~ 80		
Refrigerant	Type	-	R32		
	GWP	-	675		
	Precharged amount	g	1,400		
Piping connections (water)	Inlet / outlet diameter	inch	Male PT 1" according to ISO 7-1 (tapered pipe threads)		
Expansion vessel (heating circuit)	Volume	l	8		
Dimension	H x W x D	mm	834 x 1,239 x 330		
Weight	Empty	kg	89.5	89.5 / 90.0	
Exterior	Color / RAL code	-	Warm gray / RAL 7044		
	Voltage, phase, frequency	V, Ø, Hz	220 - 240, 1, 50		220 - 240, 1, 50 / 380 - 415, 3, 50
Power supply	Standby power consumption	W	10		
	Recommended circuit breaker	A	16	20	25 / 16

Note

1. Due to our policy of innovation, some specifications may be changed without notification.
2. Wiring cable size must comply with the applicable local and national codes. Especially the power cable and circuit breaker should be selected in accordance with that.
3. Sound power level is measured on the rated condition in accordance with ISO 9614 standard. Sound pressure level is not a value declared on Eurovent Program and is converted from sound power level based on a tonality penalty of 0 dB and installation in free-field. The directivity index (Q) is assumed as 2. Therefore, these values can be increased owing to ambient conditions during operation. Rated sound power level is in accordance with EN12102-1 under condition of EN14825.
4. Performances are in accordance with EN14511 and reflect ErP testing conditions. Above gives the declared values at rated conditions according to ErP regulation.
5. This product contains fluorinated greenhouse gases.
6. All installation sites must be equipped with an earth leakage circuit breaker (ELCB).
7. DHW 55 ~ 80°C Operating is available only when the booster heater is operating.

THERMA V™ R32 MONOBLOC S

Performance Table for Heating Operation

Maximum heating capacity (including defrost effect)

HM051MR U44

Outdoor Temperature	LWT 30 °C	LWT 35 °C	LWT 40 °C	LWT 45 °C	LWT 50 °C	LWT 55 °C	LWT 60 °C	LWT 65 °C
-25°C DB	5.50	5.50	5.50	5.50	-	-	-	-
-20°C DB	5.50	5.50	5.50	5.50	5.23	-	-	-
-15°C DB	5.50	5.50	5.50	5.50	5.23	5.23	-	-
-7°C DB	5.50	5.50	5.50	5.50	5.50	5.50	5.50	-
-4°C DB	5.50	5.50	5.50	5.50	5.50	5.50	5.50	5.50
-2°C DB	5.50	5.50	5.50	5.50	5.50	5.50	5.50	5.50
2°C DB	5.50	5.50	5.50	5.50	5.50	5.50	5.50	5.50
7°C DB	5.50	5.50	5.50	5.50	5.50	5.50	5.50	5.50
10°C DB	5.50	5.50	5.50	5.50	5.50	5.50	5.50	5.50
15°C DB	5.50	5.50	5.50	5.50	5.50	5.50	5.50	5.50
18°C DB	5.50	5.50	5.50	5.50	5.50	5.50	5.50	5.50
20°C DB	5.50	5.50	5.50	5.50	5.50	5.50	5.50	5.50
35°C DB	5.50	5.50	5.50	5.50	5.50	5.50	5.50	5.50

HM071MR U44

Outdoor Temperature	LWT 30 °C	LWT 35 °C	LWT 40 °C	LWT 45 °C	LWT 50 °C	LWT 55 °C	LWT 60 °C	LWT 65 °C
-25°C DB	5.85	5.85	5.85	5.85	-	-	-	-
-20°C DB	6.43	6.43	6.43	6.43	6.10	-	-	-
-15°C DB	7.00	7.00	7.00	7.00	6.65	6.65	-	-
-7°C DB	7.00	7.00	7.00	7.00	7.00	7.00	7.00	-
-4°C DB	7.00	7.00	7.00	7.00	7.00	7.00	7.00	7.00
-2°C DB	7.00	7.00	7.00	7.00	7.00	7.00	7.00	7.00
2°C DB	7.00	7.00	7.00	7.00	7.00	7.00	7.00	7.00
7°C DB	7.00	7.00	7.00	7.00	7.00	7.00	7.00	7.00
10°C DB	7.00	7.00	7.00	7.00	7.00	7.00	7.00	7.00
15°C DB	7.00	7.00	7.00	7.00	7.00	7.00	7.00	7.00
18°C DB	7.00	7.00	7.00	7.00	7.00	7.00	7.00	7.00
20°C DB	7.00	7.00	7.00	7.00	7.00	7.00	7.00	7.00
35°C DB	7.00	7.00	7.00	7.00	7.00	7.00	7.00	7.00

HM091MR U44 / HM093MR U44

Outdoor Temperature	LWT 30 °C	LWT 35 °C	LWT 40 °C	LWT 45 °C	LWT 50 °C	LWT 55 °C	LWT 60 °C	LWT 65 °C
-25°C DB	6.20	6.20	6.20	6.20	-	-	-	-
-20°C DB	7.60	7.60	7.60	7.60	7.22	-	-	-
-15°C DB	9.00	9.00	9.00	9.00	8.55	8.55	-	-
-7°C DB	9.00	9.00	9.00	9.00	9.00	9.00	9.00	-
-4°C DB	9.00	9.00	9.00	9.00	9.00	9.00	9.00	9.00
-2°C DB	9.00	9.00	9.00	9.00	9.00	9.00	9.00	9.00
2°C DB	9.00	9.00	9.00	9.00	9.00	9.00	9.00	9.00
7°C DB	9.00	9.00	9.00	9.00	9.00	9.00	9.00	9.00
10°C DB	9.00	9.00	9.00	9.00	9.00	9.00	9.00	9.00
15°C DB	9.00	9.00	9.00	9.00	9.00	9.00	9.00	9.00
18°C DB	9.00	9.00	9.00	9.00	9.00	9.00	9.00	9.00
20°C DB	9.00	9.00	9.00	9.00	9.00	9.00	9.00	9.00
35°C DB	9.00	9.00	9.00	9.00	9.00	9.00	9.00	9.00

Note

- DB : Dry Bulb Temperature (°C), LWT : Leaving Water Temperature (°C), LPM : Liters Per Minute (l/min), TC : Total Capacity (kW)
- Direct interpolation is permissible. Do not extrapolate.
- Measuring procedure follows EN-14511.
 - Rated values are based on standard conditions and it can be found on specifications.
 - Above table values may not be matched according to installation condition. Except for rated value, the performance is not guaranteed.
 - In accordance with the test standard (or nations), the rating will vary slightly.
- The shaded areas are not guaranteed continuous operation.

Performance Table for Cooling Operation

Maximum cooling capacity

HM051MR U44

Outdoor Temperature	LWT 7 °C	LWT 10 °C	LWT 13 °C	LWT 15 °C	LWT 18 °C	LWT 20 °C	LWT 22 °C
10°C DB	5.50	5.50	5.50	5.50	5.50	5.50	5.50
20°C DB	5.50	5.50	5.50	5.50	5.50	5.50	5.50
30°C DB	5.50	5.50	5.50	5.50	5.50	5.50	5.50
35°C DB	5.50	5.50	5.50	5.50	5.50	5.50	5.50
40°C DB	5.29	5.32	5.36	5.38	5.41	5.43	5.45
45°C DB	5.09	5.15	5.21	5.25	5.31	5.36	5.40

HM071MR U44

Outdoor Temperature	LWT 7 °C	LWT 10 °C	LWT 13 °C	LWT 15 °C	LWT 18 °C	LWT 20 °C	LWT 22 °C
10°C DB	7.00	7.00	7.00	7.00	7.00	7.00	7.00
20°C DB	7.00	7.00	7.00	7.00	7.00	7.00	7.00
30°C DB	7.00	7.00	7.00	7.00	7.00	7.00	7.00
35°C DB	7.00	7.00	7.00	7.00	7.00	7.00	7.00
40°C DB	6.36	6.45	6.55	6.61	6.71	6.77	6.84
45°C DB	5.71	5.82	5.92	5.99	6.10	6.17	6.24

HM091MR U44 / HM093MR U44

Outdoor Temperature	LWT 7 °C	LWT 10 °C	LWT 13 °C	LWT 15 °C	LWT 18 °C	LWT 20 °C	LWT 22 °C
10°C DB	9.00	9.00	9.00	9.00	9.00	9.00	9.00
20°C DB	9.00	9.00	9.00	9.00	9.00	9.00	9.00
30°C DB	9.00	9.00	9.00	9.00	9.00	9.00	9.00
35°C DB	9.00	9.00	9.00	9.00	9.00	9.00	9.00
40°C DB	7.66	7.66	7.65	7.65	7.65	7.65	7.65
45°C DB	6.31	6.35	6.39	6.42	6.45	6.48	6.51

Note

- DB : Dry Bulb Temperature (°C), LWT : Leaving Water Temperature (°C), LPM : Liters Per Minute (l/min), TC : Total Capacity (kW)
- Direct interpolation is permissible. Do not extrapolate.
- Measuring procedure follows EN-14511.
 - Rated values are based on standard conditions and it can be found on specifications.
 - Above table values may not be matched according to installation condition. Except for rated value, the performance is not guaranteed.
 - In accordance with the test standard (or nations), the rating will vary slightly.
- The shaded areas are not guaranteed continuous operation.

THERMAV™ R32 MONOBLOC S

Drawings

HM051MR U44 / HM071MR U44 / HM091MR U44 / HM093MR U44

[Unit: mm]

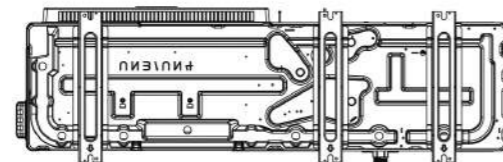
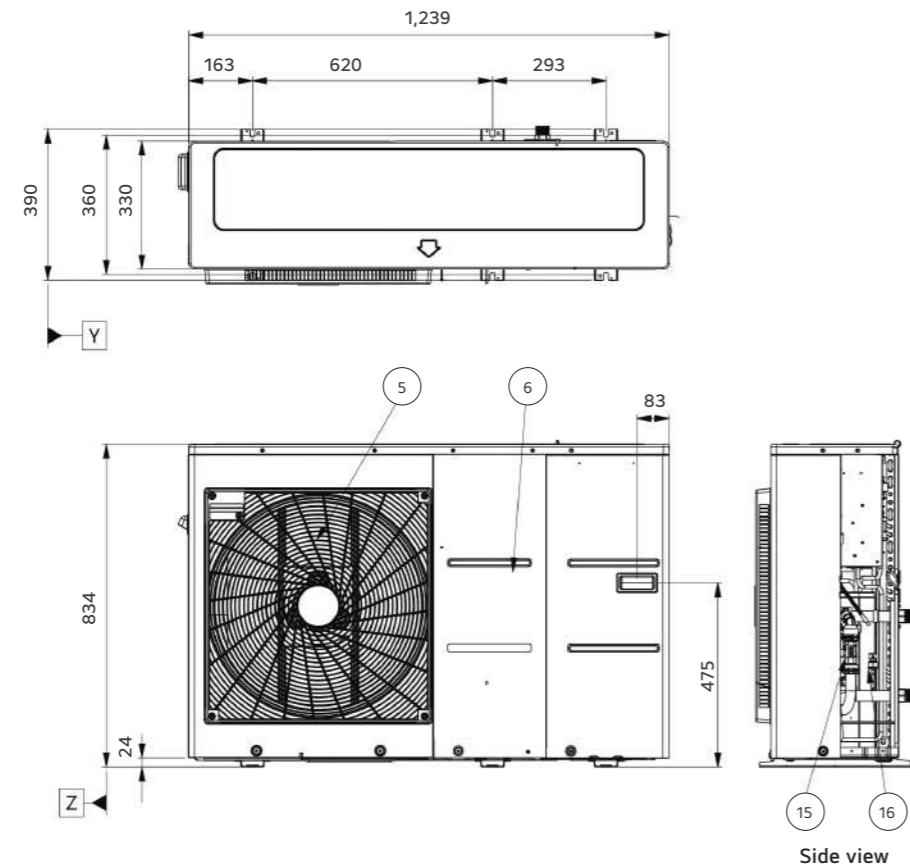

[Unit: mm]

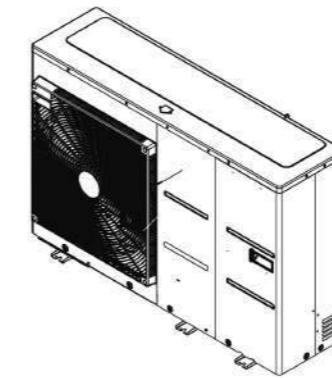

3D view

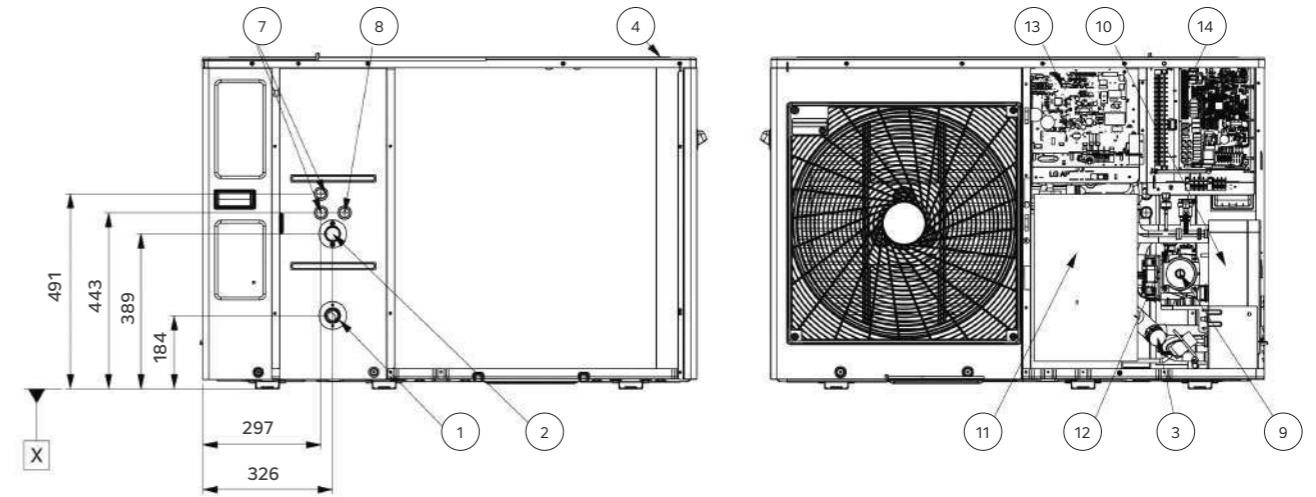

No.	Part name	Description
1	Entering water pipe	Male PT 1" according to ISO 7-1 (tapered pipe threads)
2	Leaving water pipe	Male PT 1" according to ISO 7-1 (tapered pipe threads)
3	Strainer	Filtering and stacking particles inside circulating water
4	Top cover	-
5	Front panel	-
6	Side panel	-
7	Low voltage	Communication cable hole
8	Unit power	Power cable hole
9	Water pump	To circulate water inside the system
10	Plate heat exchanger	Heat exchange between refrigerant and water
11	Compressor shield panel	-
12	Safety valve	Open at water pressure 3 bar
13	Indoor control box	Indoor PCB and terminal blocks
14	Outdoor control box	Outdoor PCB and terminal blocks
15	Flow sensor	To measure the water flow rate (5-80 LPM)
16	Pressure sensor	To measure the water pressure (0-2 MPa)

THERMA V™ R32 MONOBLOC S

Outdoor unit
 HM121MR U34
 HM141MR U34
 HM161MR U34
 HM123MR U34
 HM143MR U34
 HM163MR U34

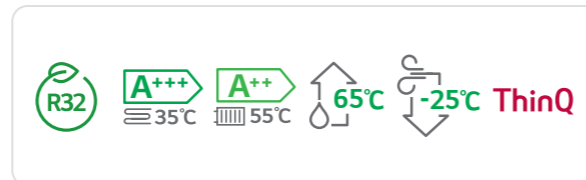

Key Components

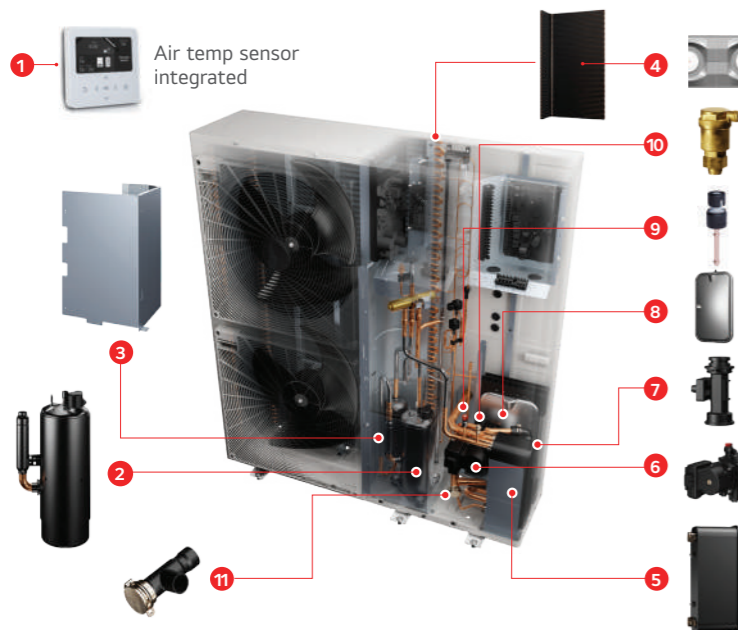

Components

- 1) Standard III remote controller ^{1), 2)}
- 2) R1 Compressor
- 3) Compressor noise shield
- 4) Black Fin heat exchanger (ref/air)
- 5) Plate type heat exchanger (ref/water)
- 6) Water pump
- 7) Water flow sensor
- 8) Expansion vessel (8 ℓ)
- 9) Water pressure sensor
- 10) Air vent valve
- 11) Strainer

1) The remote controller is supplied with the product, but it needs to be installed separately.
 2) Temperature control class (ERP class) : V

Product Specification

Efficiency Data		Unit	12 kW (1 Ø) 12 kW (3 Ø)	14 kW (1 Ø) 14 kW (3 Ø)	16 kW (1 Ø) 16 kW (3 Ø)
Seasonal space heating eff. class (35°C / 55°C)	-		A+++ / A++	A+++ / A++	A+++ / A++
Seasonal space heating efficiency (η _s) (35°C / 55°C)	%		184 / 136	182 / 135	178 / 135
SCOP (35°C / 55°C)	-		4.67 / 3.47	4.62 / 3.46	4.53 / 3.45
Sound power level	Rated / low noise mode	dB(A)	60 / 56	61 / 57	
Sound pressure level at 5m	Rated / low noise mode	dB(A)	38 / 34	39 / 35	

Nominal Capacity and COP/EER					
Air +7°C / water +35°C	Heating capacity / COP	kW / -	12.00 / 4.90	14.00 / 4.80	16.00 / 4.70
Air +2°C / water +35°C	Heating capacity / COP	kW / -	11.00 / 3.65	12.00 / 3.63	13.80 / 3.60
Air +7°C / water +55°C	Heating capacity / COP	kW / -	11.00 / 2.90	11.50 / 2.85	12.00 / 2.80
Air +35°C / water +18°C	Cooling capacity / EER	kW / -	12.00 / 4.75	14.00 / 4.30	16.00 / 4.00
Air +35°C / water +7°C	Cooling capacity / EER	kW / -	12.00 / 3.30	14.00 / 3.30	16.00 / 3.10

Outdoor Units		Unit	HM121MR U34 HM123MR U34	HM141MR U34 HM143MR U34	HM161MR U34 HM163MR U34
Operation range (outdoor air temperature)	Heating & DHW (Min. - Max.)	°C	-25 - 35		
	Cooling (Min. - Max.)	°C	5 - 48		
Operation range (leaving water temperature)	Heating (Min. - Max.)	°C	15 - 65		
	Cooling (Min. - Max.)	°C	5 - 27		
	DHW (Min. - Max.)	°C	15 - 80		
Refrigerant	Type	-	R32		
	GWP	-	675		
	Precharged amount	g	2,000		
Piping connections (water)	Inlet / outlet diameter	inch	Male PT 1" according to ISO 7-1 (tapered pipe threads)		
Expansion vessel (heating circuit)	Volume	ℓ	8		
Dimension	H x W x D	mm	1,380 x 1,239 x 330		
Weight	Empty	kg	119.1		
Exterior	Color / RAL code	-	Warm gray / RAL 7044		
Power supply	Voltage, phase, frequency	V, Ø, Hz	220 - 240, 150 / 380 - 415, 3, 50		
	Standby power consumption	W	10		
	Recommended circuit breaker	A	40 / 16		

Note

1. Due to our policy of innovation, some specifications may be changed without notification.
2. Wiring cable size must comply with the applicable local and national codes. Especially the power cable and circuit breaker should be selected in accordance with that.
3. Sound power level is measured on the rated condition in accordance with ISO 9614 standard. Sound pressure level is not a value declared on Eurovent Program and is converted from sound power level based on a tonality penalty of 0 dB and installation in free-field. The directivity index (Q) is assumed as 2. Therefore, these values can be increased owing to ambient conditions during operation. Rated sound power level is in accordance with EN12102-1 under condition of EN14825.
4. Performances are in accordance with EN14511 and reflect ErP testing conditions. Above gives the declared values at rated conditions according to ErP regulation.
5. This product contains fluorinated greenhouse gases.
6. All installation sites must be equipped with an earth leakage circuit breaker (ELCB).
7. DHW 55 - 80°C Operating is available only when the booster heater is operating.

THERMA V™ R32 MONOBLOC S

Performance Table for Heating Operation

Maximum heating capacity (including defrost effect)

HM121MR U34 / HM123MR U34

Outdoor Temperature	Capacity (kW)							
	LWT 30 °C	LWT 35 °C	LWT 40 °C	LWT 45 °C	LWT 50 °C	LWT 55 °C	LWT 60 °C	LWT 65 °C
-25°C DB	9.50	9.50	9.50	9.50	-	-	-	-
-20°C DB	10.75	10.75	10.75	10.75	10.21	-	-	-
-15°C DB	12.00	12.00	12.00	12.00	11.50	11.50	-	-
-7°C DB	12.00	12.00	12.00	12.00	12.00	12.00	12.00	-
-4°C DB	12.00	12.00	12.00	12.00	12.00	12.00	12.00	12.00
-2°C DB	12.00	12.00	12.00	12.00	12.00	12.00	12.00	12.00
2°C DB	12.00	12.00	12.00	12.00	12.00	12.00	12.00	12.00
7°C DB	12.00	12.00	12.00	12.00	12.00	12.00	12.00	12.00
10°C DB	12.00	12.00	12.00	12.00	12.00	12.00	12.00	12.00
15°C DB	12.00	12.00	12.00	12.00	12.00	12.00	12.00	12.00
18°C DB	12.00	12.00	12.00	12.00	12.00	12.00	12.00	12.00
20°C DB	12.00	12.00	12.00	12.00	12.00	12.00	12.00	12.00
35°C DB	12.00	12.00	12.00	12.00	12.00	12.00	12.00	12.00

HM141MR U34 / HM143MR U34

Outdoor Temperature	Capacity (kW)							
	LWT 30 °C	LWT 35 °C	LWT 40 °C	LWT 45 °C	LWT 50 °C	LWT 55 °C	LWT 60 °C	LWT 65 °C
-25°C DB	10.00	10.00	10.00	10.00	-	-	-	-
-20°C DB	12.00	12.00	12.00	12.00	11.40	-	-	-
-15°C DB	14.00	14.00	14.00	14.00	13.30	13.30	-	-
-7°C DB	14.00	14.00	14.00	14.00	14.00	14.00	14.00	-
-4°C DB	14.00	14.00	14.00	14.00	14.00	14.00	14.00	14.00
-2°C DB	14.00	14.00	14.00	14.00	14.00	14.00	14.00	14.00
2°C DB	14.00	14.00	14.00	14.00	14.00	14.00	14.00	14.00
7°C DB	14.00	14.00	14.00	14.00	14.00	14.00	14.00	14.00
10°C DB	14.00	14.00	14.00	14.00	14.00	14.00	14.00	14.00
15°C DB	14.00	14.00	14.00	14.00	14.00	14.00	14.00	14.00
18°C DB	14.00	14.00	14.00	14.00	14.00	14.00	14.00	14.00
20°C DB	14.00	14.00	14.00	14.00	14.00	14.00	14.00	14.00
35°C DB	14.00	14.00	14.00	14.00	14.00	14.00	14.00	14.00

HM161MR U34 / HM163MR U34

Outdoor Temperature	Capacity (kW)							
	LWT 30 °C	LWT 35 °C	LWT 40 °C	LWT 45 °C	LWT 50 °C	LWT 55 °C	LWT 60 °C	LWT 65 °C
-25°C DB	10.50	10.50	10.50	10.50	-	-	-	-
-20°C DB	13.25	13.25	13.25	13.25	12.59	-	-	-
-15°C DB	16.00	14.40	14.40	14.40	13.68	13.68	-	-
-7°C DB	16.00	16.00	16.00	16.00	16.00	16.00	16.00	-
-4°C DB	16.00	16.00	16.00	16.00	16.00	16.00	16.00	16.00
-2°C DB	16.00	16.00	16.00	16.00	16.00	16.00	16.00	16.00
2°C DB	16.00	16.00	16.00	16.00	16.00	16.00	16.00	16.00
7°C DB	16.00	16.00	16.00	16.00	16.00	16.00	16.00	16.00
10°C DB	16.00	16.00	16.00	16.00	16.00	16.00	16.00	16.00
15°C DB	16.00	16.00	16.00	16.00	16.00	16.00	16.00	16.00
18°C DB	16.00	16.00	16.00	16.00	16.00	16.00	16.00	16.00
20°C DB	16.00	16.00	16.00	16.00	16.00	16.00	16.00	16.00
35°C DB	16.00	16.00	16.00	16.00	16.00	16.00	16.00	16.00

Note

- DB : Dry Bulb Temperature (°C), LWT : Leaving Water Temperature (°C), LPM : Liters Per Minute (l/min), TC : Total Capacity (kW)
- Direct interpolation is permissible. Do not extrapolate.
- Measuring procedure follows EN-14511.
 - Rated values are based on standard conditions and it can be found on specifications.
 - Above table values may not be matched according to installation condition. Except for rated value, the performance is not guaranteed.
 - In accordance with the test standard (or nations), the rating will vary slightly.
- The shaded areas are not guaranteed continuous operation.

Performance Table for Cooling Operation

Maximum cooling capacity

HM121MR U34 / HM123MR U34

Outdoor Temperature	Capacity (kW)						
	LWT 7 °C	LWT 10 °C	LWT 13 °C	LWT 15 °C	LWT 18 °C	LWT 20 °C	LWT 22 °C
10°C DB	12.00	12.00	12.00	12.00	12.00	12.00	12.00
20°C DB	12.00	12.00	12.00	12.00	12.00	12.00	12.00
30°C DB	12.00	12.00	12.00	12.00	12.00	12.00	12.00
35°C DB	12.00	12.00	12.00	12.00	12.00	12.00	12.00
40°C DB	11.05	11.19	11.33	11.43	11.57	11.67	11.76
45°C DB	10.10	10.37	10.64	10.83	11.10	11.28	11.46

HM141MR U34 / HM143MR U34

Outdoor Temperature	Capacity (kW)						
	LWT 7 °C	LWT 10 °C	LWT 13 °C	LWT 15 °C	LWT 18 °C	LWT 20 °C	LWT 22 °C
10°C DB	12.50	12.80	13.10	13.30	13.60	13.80	14.00
20°C DB	14.00	14.00	14.00	14.00	14.00	14.00	14.00
30°C DB	14.00	14.00	14.00	14.00	14.00	14.00	14.00
35°C DB	14.00	14.00	14.00	14.00	14.00	14.00	14.00
40°C DB	12.35	12.60	12.84	13.01	13.26	13.42	13.59
45°C DB	10.69	11.19	11.69	12.02	12.51	12.84	13.17

HM161MR U34 / HM163MR U34

Outdoor Temperature	Capacity (kW)						
	LWT 7 °C	LWT 10 °C	LWT 13 °C	LWT 15 °C	LWT 18 °C	LWT 20 °C	LWT 22 °C
10°C DB	13.00	13.60	14.20	14.60	15.20	15.60	16.00
20°C DB	16.00	16.00	16.00	16.00	16.00	16.00	16.00
30°C DB	16.00	16.00	16.00	16.00	16.00	16.00	16.00
35°C DB	16.00	16.00	16.00	16.00	16.00	16.00	16.00
40°C DB	13.60	13.96	14.32	14.56	14.92	15.16	15.40
45°C DB	11.20	11.76	12.32	12.69	13.25	13.62	14.00

Note

- DB : Dry Bulb Temperature (°C), LWT : Leaving Water Temperature (°C), LPM : Liters Per Minute (l/min), TC : Total Capacity (kW)
- Direct interpolation is permissible. Do not extrapolate.
- Measuring procedure follows EN-14511.
 - Rated values are based on standard conditions and it can be found on specifications.
 - Above table values may not be matched according to installation condition. Except for rated value, the performance is not guaranteed.
 - In accordance with the test standard (or nations), the rating will vary slightly.
- The shaded areas are not guaranteed continuous operation.

THERMAV™ R32 MONOBLOC S

Drawings

HM121MR U34 / HM141MR U34 / HM161MR U34
 HM123MR U34 / HM143MR U34 / HM163MR U34

[Unit: mm]

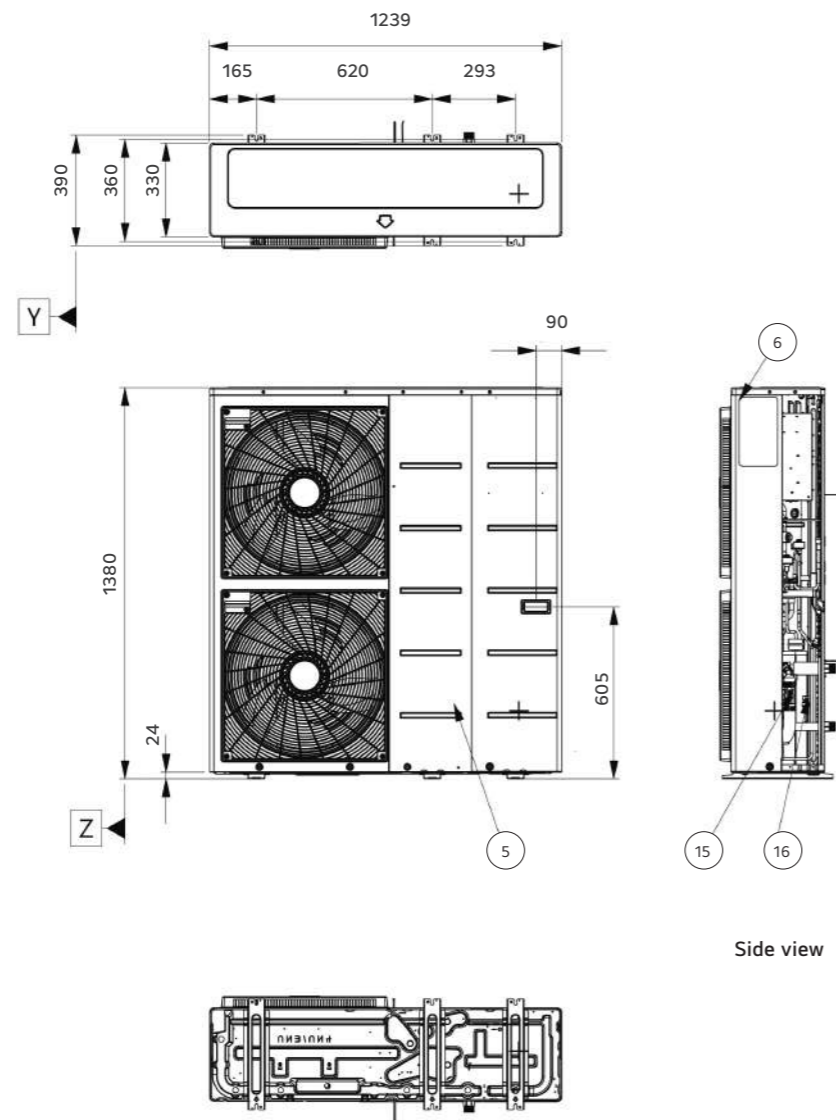

Side view



3D view

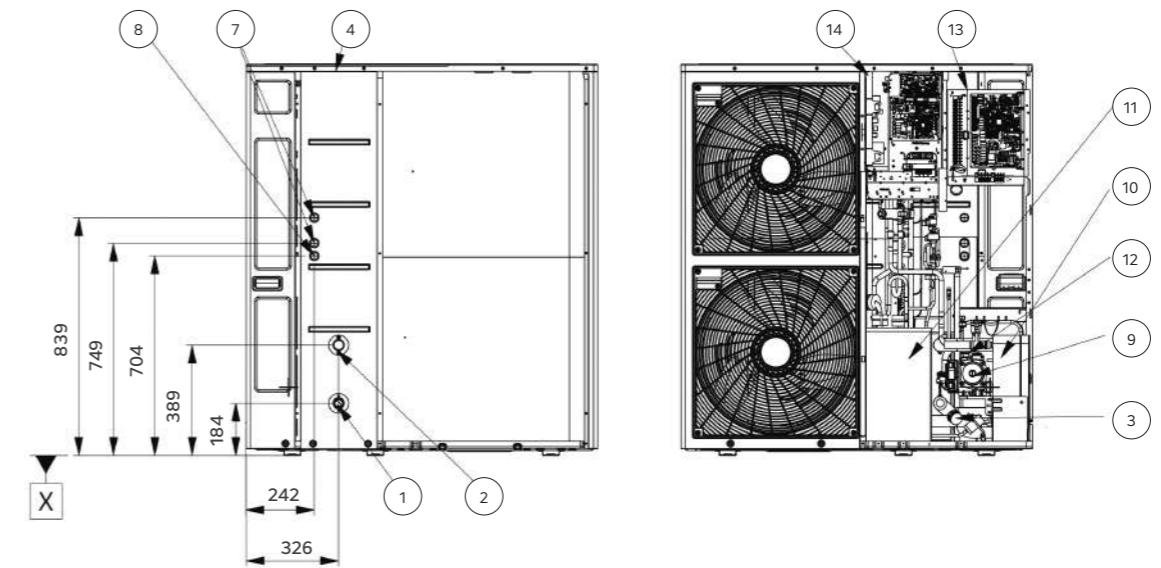

No.	Part name	Description
1	Entering water pipe	Male PT 1" according to ISO 7-1 (tapered pipe threads)
2	Leaving water pipe	Male PT 1" according to ISO 7-1 (tapered pipe threads)
3	Strainer	Filtering and stacking particles inside circulating water
4	Top cover	-
5	Front panel	-
6	Side panel	-
7	Low voltage	Communication cable hole
8	Unit power	Power cable hole
9	Water pump	To circulate water inside the system
10	Plate heat exchanger	Heat exchange between refrigerant and water
11	Compressor shield panel	-
12	Safety valve	Open at water pressure 3 bar
13	Indoor control box	Indoor PCB and terminal blocks
14	Outdoor control box	Outdoor PCB and terminal blocks
15	Flow sensor	To measure the water flow rate (5-80 LPM)
16	Pressure sensor	To measure the water pressure (0-2 MPa)

THERMA V™ R32 MONOBLOC S

Electric Backup Heater

HA031M E1
HA061M E1
HA063M E1

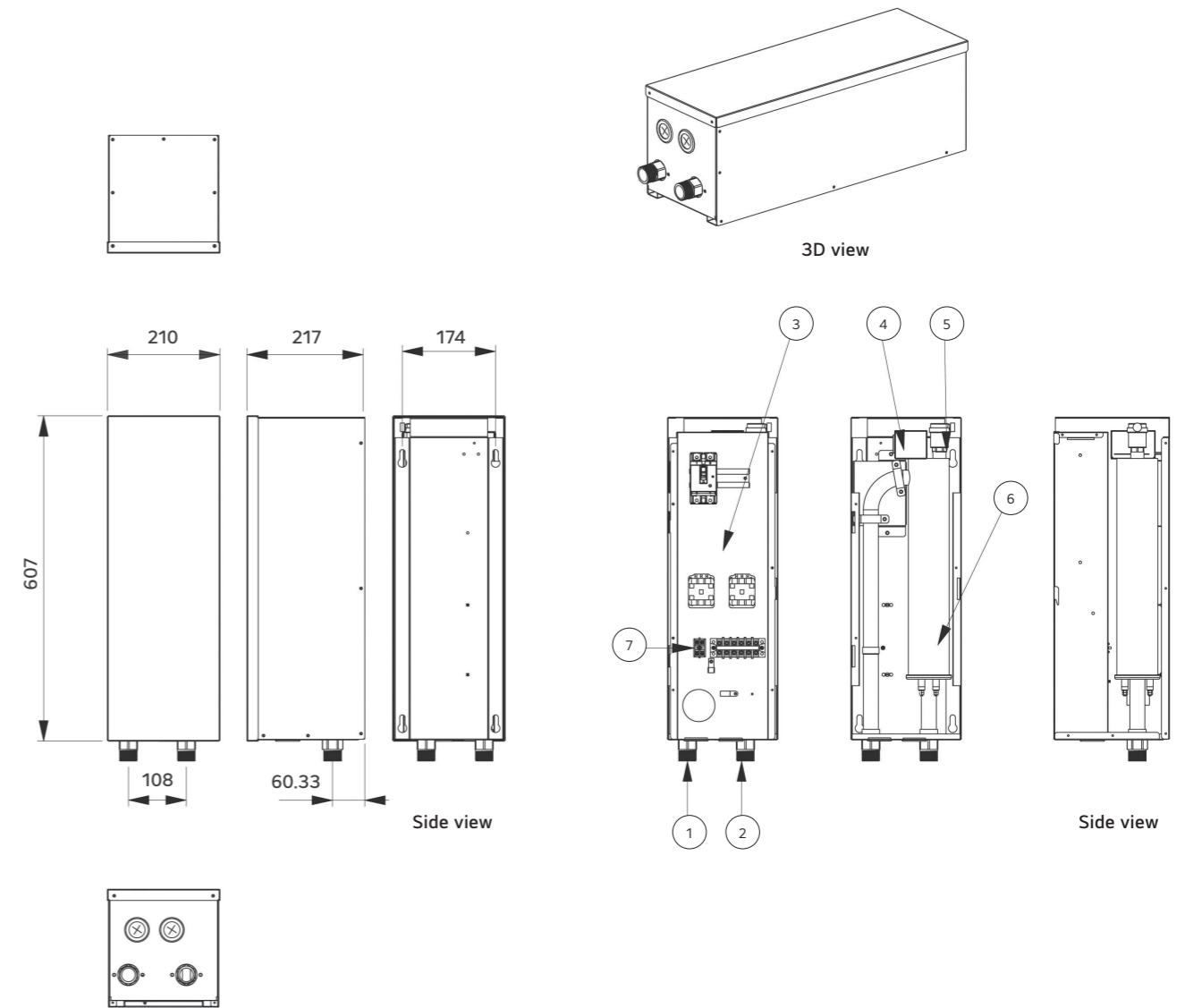
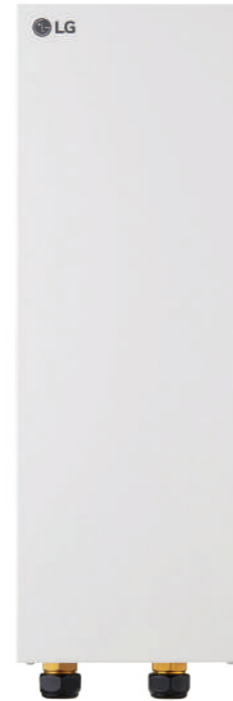

Backup heater specification

Electrical specification		Unit	HA031M E1	HA061M E1	HA063M E1
Backup heater	Type	-	Sheath		
	Number of heating coil	EA	1	2	3
	Capacity combination	kW	3.0	3.0 + 3.0	2.0 + 2.0 + 2.0
	Heating steps	Step	1	2	1
	Power supply	V, Ø, Hz	220 ~ 240, 1, 50		380 ~ 415, 3, 50
	Rated running current	A	12.5	25.0	8.7
	Dimensions (H x W x D)	mm	607 x 210 x 217		
Net weight (unit)	kg	12.8	13.4	13.1	
Wiring connections	Power supply cable (included earth, H07RN-F)	mm ² x cores	1.5 x 3 C	4.0 x 3 C	2.5 x 4 C
	Communication cable (H07RN-F)	mm ² x cores	0.75 x 4 C		0.75 x 2 C

Note
1. Due to our policy of innovation some specifications may be changed without notification.
2. Wiring cable size must comply with the applicable local and national codes.
Especially the power cable and circuit breaker should be selected in accordance with that.

No.	Part name	Description
1	Leaving water pipe	Male PT 1" according to ISO 7-1 (tapered pipe threads)
2	Entering water pipe	Male PT 1" according to ISO 7-1 (tapered pipe threads)
3	Control box	Circuit breaker, Magnetic switch, Terminal blocks
4	Thermal switch	Cut-off power input to E/heater at 90°C
5	Air vent	Air purging when charging water
6	Electric heater	Support the space heating at very cold temperature and in case of emergency
7	Backup heater outlet sensor	Connect to unit (heat pump)

THERMA V™

R32 Hydrosplit Hydro Unit

Only Water Enters Your Home



What is R32 Hydrosplit Hydro Unit

The LG THERMA V Hydrosplit series is a simple, safe heat pump that eliminating the risk of indoor refrigerant leakage by connecting outdoor unit and indoor unit using water piping.

Since the indoor unit of R32 Hydrosplit Hydro Unit is installed on the wall rather than on the floor, space is not wasted, and the light weight enables quick installation. This makes it perfect for renovation projects. Also, it has good maintainability because the indoor unit is located indoors, for example in a machine room.

Product Range

Phase	Capacity (kW)	Indoor Unit	Outdoor Unit
1 Ø	12	HN1600MC NK1	HU121MRB U30
	14		HU141MRB U30
	16		HU161MRB U30
3 Ø	9		HU123MRB U30
	12		HU143MRB U30
	16		HU163MRB U30

Key Features

- Capacity range from 12 to 16 kW for renovation and large new build
- R32 refrigerant with reduced Global Warming Potential (GWP)
- No need for F-gas license and simple installation due to no refrigerant piping work
- Operation range down to -25°C
- Maximum flow temperature up to 65°C
- High level hydronic components integration for fast and clean installation

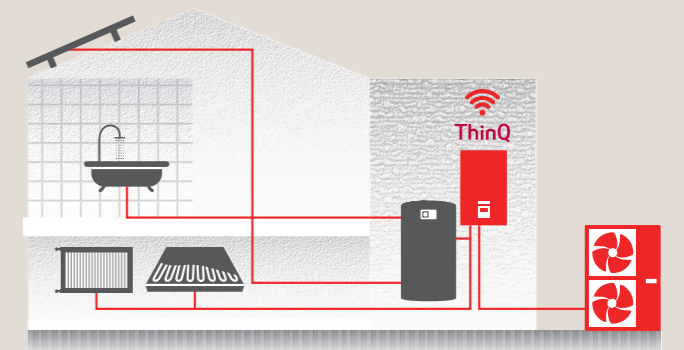

Excellent performance & efficiency

- R32 refrigerant
- R1 Compressor
- Flash gas injection
- Wide operation range
- Black Fin heat exchanger
- Solar thermal
- Energy state
- Modbus connectivity

User convenience

- Intuitive interface
- LG ThinQ
- 2nd circuit
- Various control options
- Seasonal auto mode
- 3rd party boiler
- Energy monitoring
- DHW recirculation
- Low noise mode
- Advanced pump control options
- 2 remote control

Easy installation & maintenance

- Hydrosplit concept
- LG BECON cloud
- Clip connection

THERMA V™ R32

HIGHLIGHT OF R32 HYDROPLIT HYDRO UNIT



Browse now



Simple Installation without Refrigerant Piping

- No need for F-gas license, because outdoor and indoor unit are connected by water pipes
- As hydronic parts are packaged inside indoor units, the installation can be realized with minimum usage of space
- Refrigerant is hermetically sealed inside outdoor unit



Remarkable Heating Performance even in Cold Weather

- Wide operation range down to -25°C
- 100 % heating capacity at -7°C ambient temp. (@ LWT 35°C)
- Reduces energy bills with the highest energy efficiency of A+++ (@ 35°C)



No Risk of Indoor Refrigerant Leakage

The Hydrosplit architecture, with no refrigerant circulating indoors, makes it possible to expand the living space, as the minimum floor area requirements do not apply.

Hydrosplit Concept

The THERMA V R32 Hydrosplit Hydro Unit connects an IDU and ODU by water pipes due to the heat exchanger's location in the outdoor unit, thus reducing the risk of indoor refrigerant leakage.

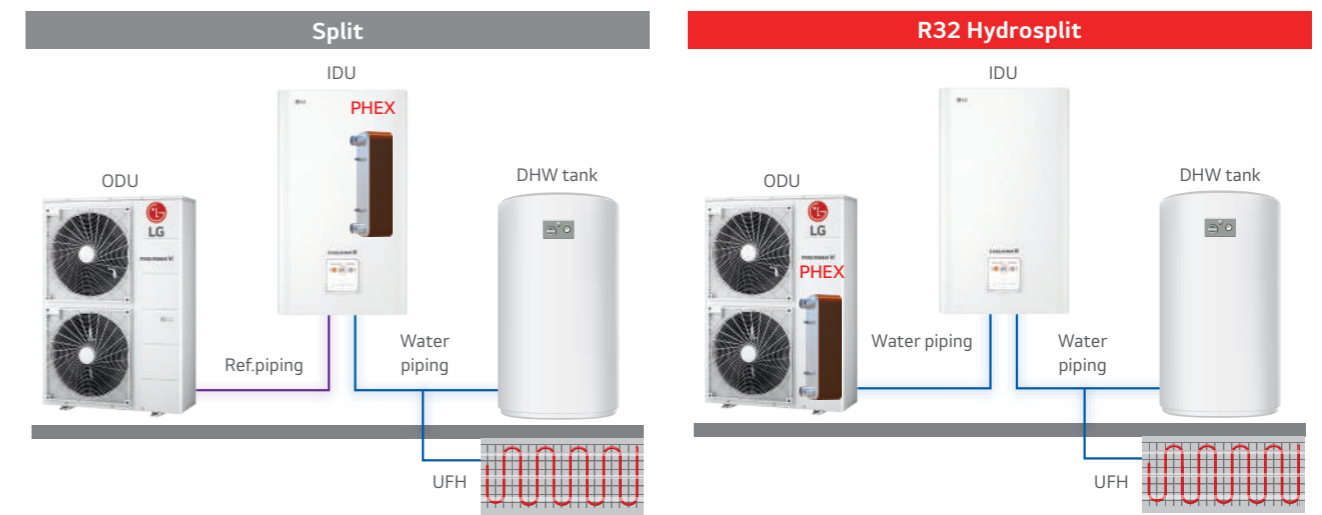

If piping length between IDU and ODU is 30 m

The IDU should be installed in a room with a floor area larger than 10 m²

1) Total Ref. Amount 2.7 kg
- Pre-Charged Ref. Amount : 2.1 kg
- Additional Ref. Charge Amount for 30 m : 0.6 kg

2) Based on 1.5 m installed height
3) IEC 60335-2-40 6 th edition applied

No minimum floor area requirement

THERMAV™ R32 HYDROSPLIT HYDRO UNIT

Outdoor unit

HU121MRB U30 / HU123MRB U30
 HU141MRB U30 / HU143MRB U30
 HU161MRB U30 / HU163MRB U30

Indoor unit

HN1600MC NK1

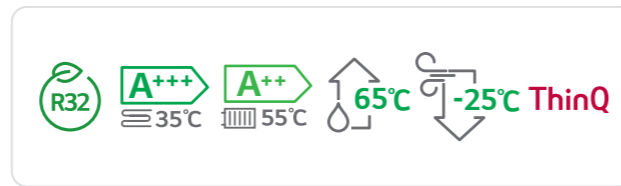
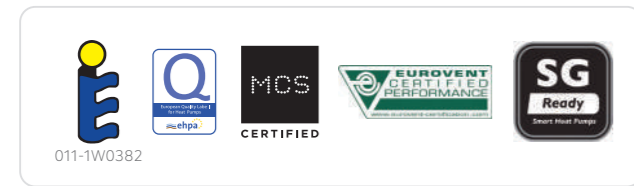

Key Components

Hydro Unit

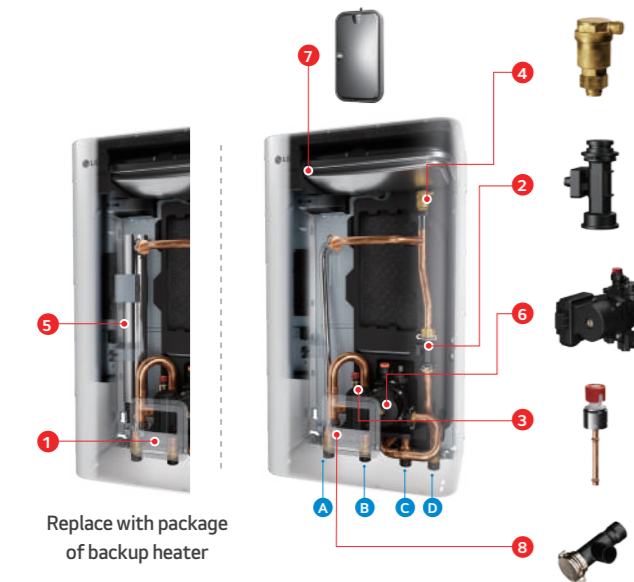

Replace with package of backup heater

Components

- 1 Standard III remote controller¹⁾ (air temp. sensor integrated)
- 2 Flow sensor
- 3 Water pressure sensor
- 4 Air vent valve
- 5 Backup electric heater (6 kW, accessory)
- 6 Water pump
- 7 Expansion vessel (8 ℓ)
- 8 Strainer

1) Temperature control class (ERP class) : V

Connections

- A Heating circuit outlet pipe (male PT 1")
- B Heating circuit inlet pipe (male PT 1")
- C Outlet pipe to outdoor unit (male PT 1")
- D Inlet pipe from outdoor unit (male PT 1")

Product Specification

Efficiency Data		Unit	12 kW (1 Ø) 12 kW (3 Ø)	14 kW (1 Ø) 14 kW (3 Ø)	16 kW (1 Ø) 16 kW (3 Ø)
Seasonal space heating eff. class (35°C / 55°C)		-	A+++/A++	A+++/A++	A+++/A++
Seasonal space heating efficiency (η _s) (35°C / 55°C)		%	181 / 137	180 / 136	179 / 135
SCOP (35°C / 55°C)		-	4.60 / 3.50	4.57 / 3.47	4.55 / 3.45
Sound power level (outdoor unit)	Rated / low noise mode	dB(A)	61 / 60	62 / 60	63 / 60
Sound pressure level at 5m (outdoor unit)	Rated / low noise mode	dB(A)	39 / 38	40 / 38	41 / 38
Sound power level (indoor unit)	Rated	dB(A)	44		
Sound pressure level at 1m (indoor unit)	Rated	dB(A)	36		

Nominal Capacity and COP/EER

Air / water temperature	Heating capacity / COP	kW / -	12 kW / 5.04	14 kW / 4.89	16 kW / 4.80
Air +7°C / water +35°C	Heating capacity / COP	kW / -	11.00 / 3.65	12.00 / 3.63	13.80 / 3.60
Air +7°C / water +55°C	Heating capacity / COP	kW / -	11.00 / 2.90	11.50 / 2.85	12.00 / 2.80
Air +35°C / water +18°C	Cooling capacity / EER	kW / -	12.00 / 4.75	14.00 / 4.30	16.00 / 4.00
Air +35°C / water +7°C	Cooling capacity / EER	kW / -	12.00 / 2.70	14.00 / 2.60	16.00 / 2.50

Outdoor Units		Unit	HU121MRB U30 HU123MRB U30	HU141MRB U30 HU143MRB U30	HU161MRB U30 HU163MRB U30
Operation range (outdoor air temperature)	Heating & DHW (Min. ~ Max.)	°C	-25 ~ 35		
	Cooling (Min. ~ Max.)	°C	5 ~ 48		
Refrigerant	Type	-	R32		
	GWP	-	675		
	Precharged amount	g	2,100		
Piping connections (water)	Inlet / outlet diameter	inch	Male PT 1" according to ISO 7-1 (tapered pipe threads)		
Dimension	H x W x D	mm	1,380 x 950 x 330		
Weight	Empty	kg	91.7		
Exterior	Color / RAL code	-	Warm gray / RAL 7044		
	Voltage, phase, frequency (1Ø/3Ø)	V, Ø, Hz	220 - 240, 1, 50 / 380 - 415, 3, 50		
Power supply	Standby power consumption	W	60		
	Recommended circuit breaker (1Ø/3Ø)	A	40 / 16		

Indoor Units		Unit	HN1600MC NK1
Operation range (leaving water temperature)	Heating (Min. ~ Max.)	°C	15 ~ 65
	Cooling (Min. ~ Max.)	°C	5 ~ 27
	DHW (Min. ~ Max.)	°C	15 ~ 80
Expansion vessel (heating circuit)	Volume	ℓ	8
Piping connections (water)	Outlet to outdoor unit	inch	Male PT 1" according to ISO 7-1 (tapered pipe threads)
	Inlet from outdoor unit	inch	
	Outlet to heat load	inch	
Dimension	H x W x D	mm	850 x 490 x 315
	Weight	Empty	kg
Exterior	Color / RAL code	-	Noble white / RAL 9016

Note

1. Due to our policy of innovation, some specifications may be changed without notification.
2. Wiring cable size must comply with the applicable local and national codes. Especially the power cable and circuit breaker should be selected in accordance with that.
3. Sound power level is measured on the rated condition in accordance with ISO 9614 standard. Sound pressure level is not a value declared on Eurovent Program and is converted from sound power level based on a tonality penalty of 0 dB and installation in free-field. The directivity index (Q) is assumed as 2. Therefore, these values can be increased owing to ambient conditions during operation. Rated sound power level is in accordance with EN12102-1 under condition of EN14825.
4. Performances are in accordance with EN14511 and reflect ErP testing conditions. Above gives the declared values at rated conditions according to ErP regulation.
5. This product contains fluorinated greenhouse gases.
6. All installation sites must be equipped with an earth leakage circuit breaker (ELCB).
7. DHW 55 ~ 80°C Operating is available only when the booster heater is operating.

R32 HYDROSPLIT HYDRO UNIT

Accessory Parts (Optional Accessory)

Accessory backup heater for Hydrosplit Hydro Unit

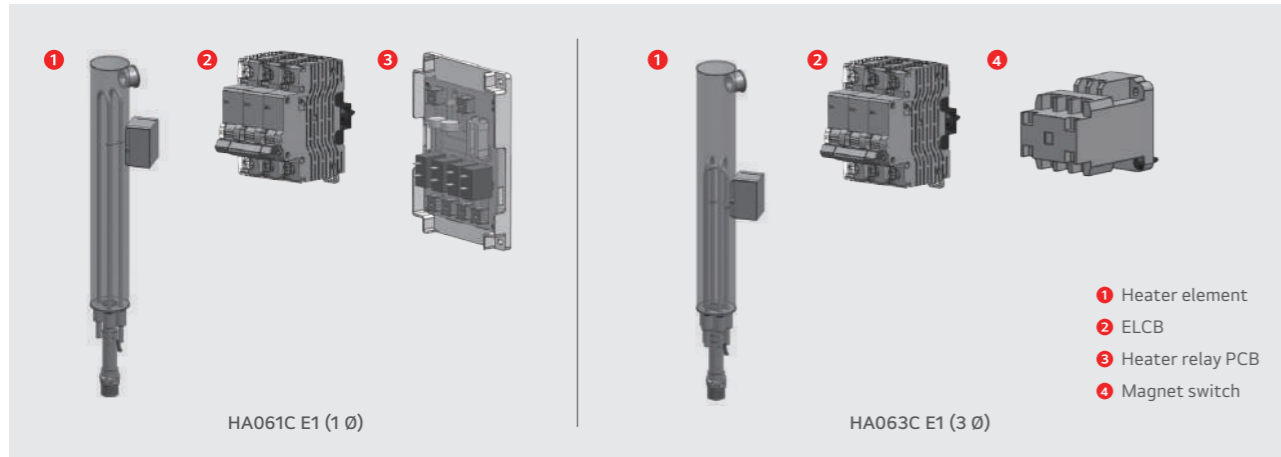

Electrical specification			HA061C E1	HA063C E1
Backup heater	Capacity combination	kW	3.0 + 3.0	2.0 + 2.0 + 2.0
	Heating steps	Steps	1	1
	Power supply	V, Ø, Hz	220 ~ 240, 1, 50	380 ~ 415, 3, 50
	Rated running current	A	24.0	8.7

* The backup heater should be purchased and installed separately.

Supplied Parts

Strainer

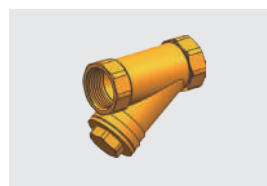

Technical specification		Details
Material	Body	Brass
	Mesh	Stainless steel (STS304)
Mesh	Mesh no.	30
	Max. particle size	0.6 mm
Piping connection		Female G 1" according to ISO 228-1

* The strainer is supplied with the product, but it needs to be installed separately.

* This strainer should be installed at the inlet connection of the outdoor unit to protect the clogging of a plate heat exchanger.



THERMAV™ R32 HYDROSPLIT HYDRO UNIT

Drawings

HU121MRB U30 / HU141MRB U30 / HU161MRB U30
HU123MRB U30 / HU143MRB U30 / HU163MRB U30

[Unit: mm]

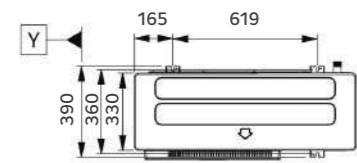

3D view

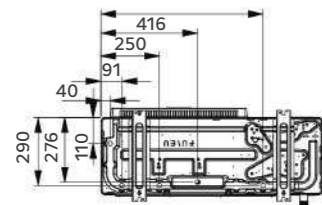
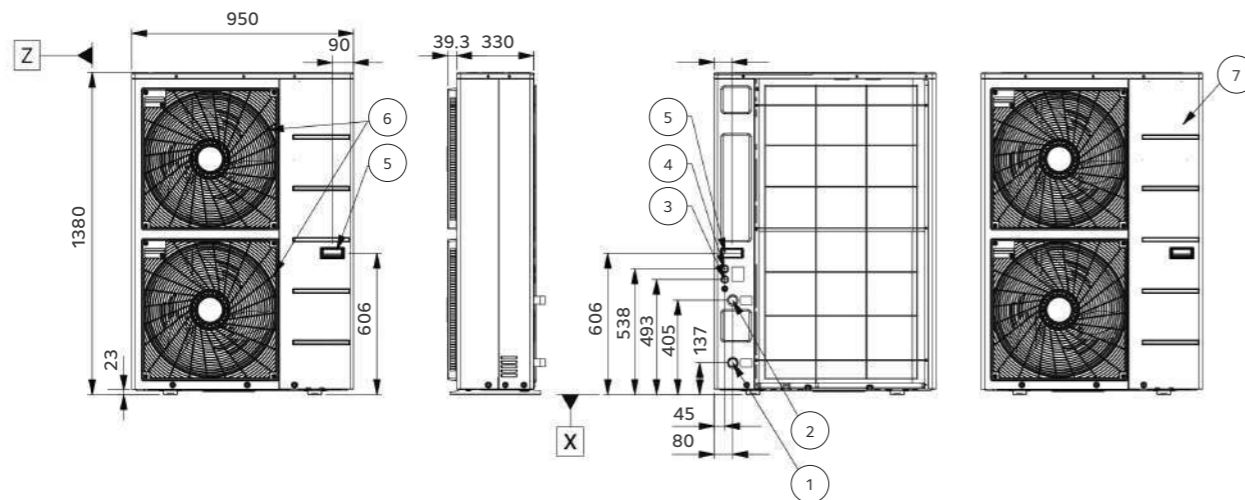

No.	Part name	Description
1	Entering water pipe	Male PT 1" according to ISO 7-1 (tapered pipe threads)
2	Leaving water pipe	Male PT 1" according to ISO 7-1 (tapered pipe threads)
3	Unit power	Power cable hole
4	Low voltage	Communication cable hole
5	Handle	-
6	Air outlet	-
7	Side panel	-

HN1600MC NK1

[Unit: mm]

External

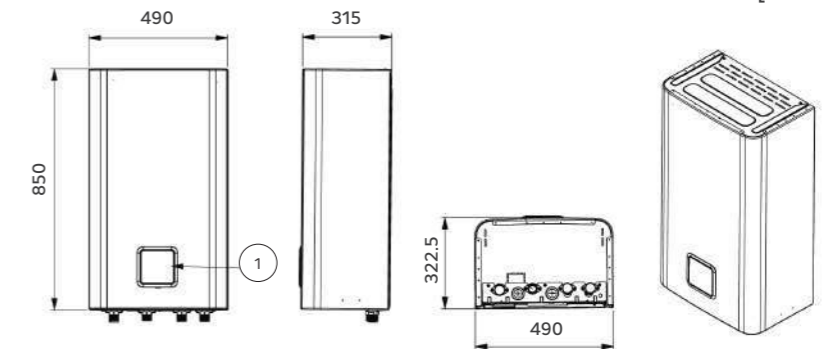

No.	Part name	Description
1	Control panel	Built-in remote controller

Internal

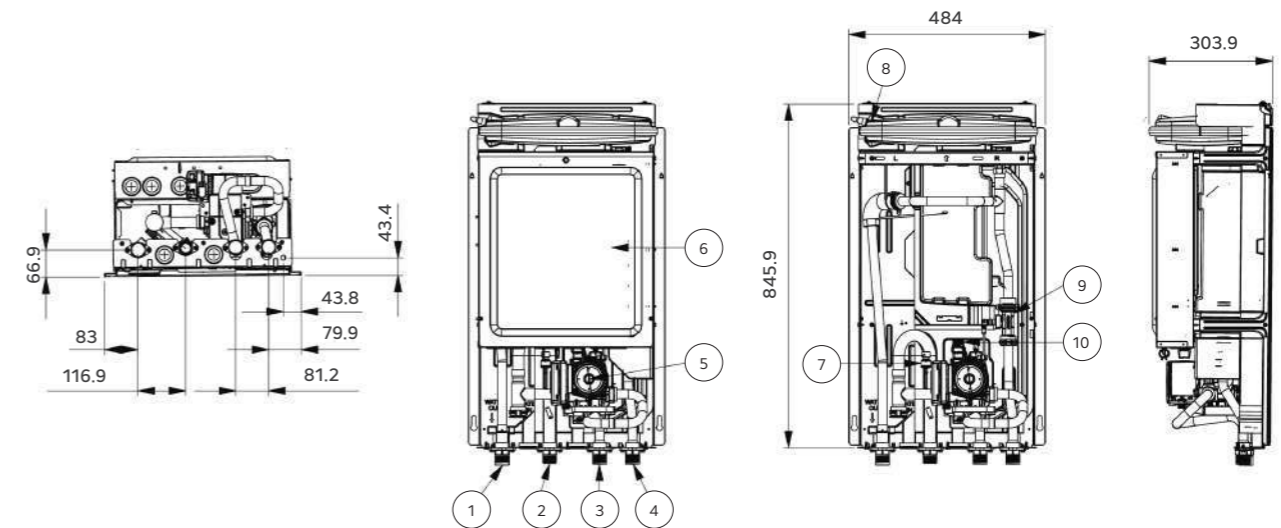

No.	Part name	Description
1	Heating circuit outlet pipe	Male PT 1" according to ISO 7-1 (tapered pipe threads)
2	Heating circuit inlet pipe	Male PT 1" according to ISO 7-1 (tapered pipe threads)
3	Outlet pipe to outdoor unit	Male PT 1" according to ISO 7-1 (tapered pipe threads)
4	Inlet pipe to outdoor unit	Male PT 1" according to ISO 7-1 (tapered pipe threads)
5	Water pump	To circulate water inside the system
6	Control box	PCB and Terminal blocks
7	Pressure sensor	To measure the water pressure (0-2MPa)
8	Expansion tank	8 Liter, 3/4" connection
9	Flow sensor	To measure the water flow rate (5-80 LPM)
10	Safety valve	Open at water pressure 3 bar

THERMA V™

R32 Hydrosplit Combi Unit

Perfect Space-Saving Solution



What is R32 Hydrosplit Combi Unit

The LG THERMA V Hydrosplit series is a simple, safe heat pump that eliminating the risk of indoor refrigerant leakage by connecting outdoor unit and indoor unit using water piping. R32 Hydrosplit Combi Unit is the perfect space-saving solution for heating, cooling and hot water supply due to its fully integrated hot water tank. This all-in-one solution's hydronic and domestic hot water components are pre-wired, reducing installation time and space occupancy, making it perfect for new builds.

Product Range

Phase	Capacity (kW)	Indoor Unit	Outdoor Unit
1 Ø	12	HN1616Y NB1	HU121MRB U30
	14		HU141MRB U30
	16		HU161MRB U30
3 Ø	12		HU123MRB U30
	14		HU143MRB U30
	16		HU163MRB U30

Key Features

- Capacity range from 12 to 16 kW for renovation and large new build
- R32 refrigerant with reduced Global Warming Potential (GWP)
- No need for F-gas license and simple installation due to no refrigerant piping work
- Operation range down to -25°C
- Maximum flow temperature up to 65°C
- All-in-one Combi Unit with integrated hot water cylinder

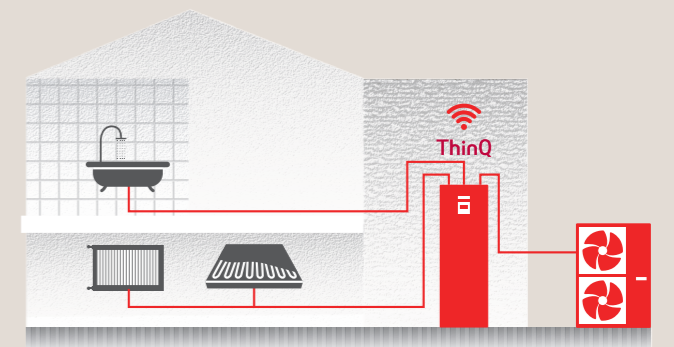

Excellent performance & efficiency

- R1 Compressor
- R32 refrigerant
- Flash gas injection
- Wide operation range
- Black Fin heat exchanger
- Energy state
- Modbus connectivity

User convenience

- Harmonious exterior
- Intuitive interface
- LG ThinQ
- 2nd circuit
- Various pump control options
- Seasonal auto mode
- 3rd party boiler
- Low noise mode
- Advanced pump control options
- 2 remote control

Easy installation & maintenance

- Hydrosplit concept
- Water tank integration
- Clip connection



[Browse now](#)



All-in-one Integration (Combi Unit)

- Integrated indoor unit with a hot water storage tank
- Saves space in the technical room with a small footprint
- Installation time reduced with pre-installed components
- Harmonized with other household appliances for a cohesive exterior



Sophisticated and Harmonious Exterior

The indoor unit's sleek design fits into diverse indoor spaces, such as a utility or laundry room, a garage or a kitchen.



Save Space and Time

Unlike in the case of a conventional system, this all-in-one solution requires reduced installation time and saves valuable living space.

Hydrosplit Concept

The THERMA V R32 Hydrosplit Combi Unit connects an IDU and ODU by water pipes due to the heat exchanger's location in the outdoor unit, thus reducing the risk of indoor refrigerant leakage.

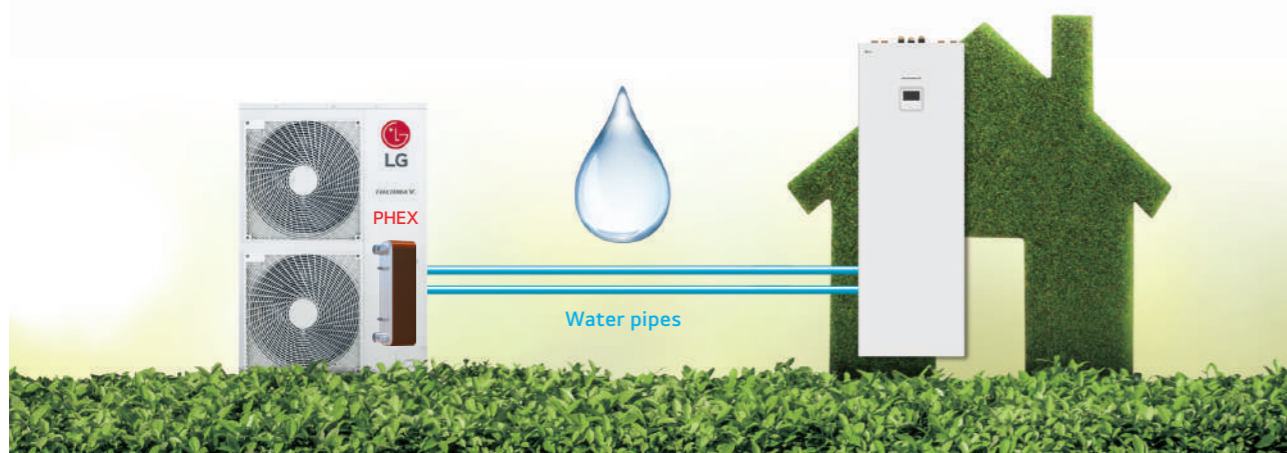

THERMA V™ R32 HYDROSPLIT COMBI UNIT

Outdoor unit

HU121MRB U30 / HU123MRB U30
 HU141MRB U30 / HU143MRB U30
 HU161MRB U30 / HU163MRB U30

Indoor unit

HN1616Y NB1

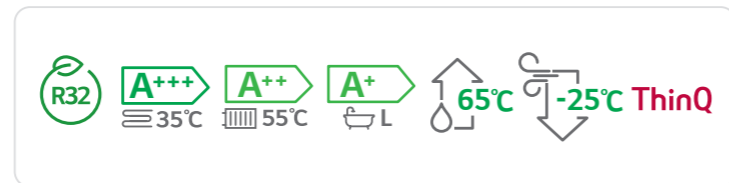
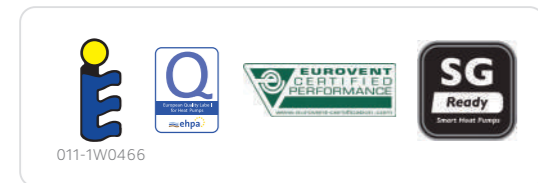

Key Components

Combi Unit



Components

- 1 DHW storage tank (200 l)
- 2 Main water pump
- 3 Water pump for DHW charging
- 4 Plate heat exchanger for DHW (water / DHW)
- 5 Electric heater (max. 6 kW)
- 6 3-way diverting valve
- 7 Expansion vessel for heating (12 l)
- 8 Flow sensor
- 9 Water pressure sensor
- 10 Expansion vessel for DHW (8 l, option)
- 11 Buffer tank (40 l, option)
- 12 Standard III remote controller¹⁾ (attached on the front panel)

1) Temperature control class (ERP class) : V

Connections

- A Inlet pipe from outdoor unit (female G1")
- B Outlet pipe to outdoor unit (female G1")
- C Domestic hot water outlet pipe (female G3/4")
- D Domestic cold water outlet pipe (female G3/4")
- E DHW recirculation pipe (female G3/4")
- F Heating circuit inlet pipe (female G1")
- G Heating circuit outlet pipe (female G1")

Product Specification

Efficiency Data	Unit	12 kW (1 Ø) 12 kW (3 Ø)			14 kW (1 Ø) 14 kW (3 Ø)			16 kW (1 Ø) 16 kW (3 Ø)		
Seasonal space heating eff. class (35°C / 55°C)	-	A+++/A++			A+++/A++			A+++/A++		
Seasonal space heating efficiency (η_s) (35°C / 55°C)	%	181 / 137			180 / 136			179 / 135		
SCOP (35°C / 55°C)	-	4.60 / 3.50			4.57 / 3.47			4.55 / 3.45		
Declared load profile, average climate	-	L			L			L		
Water heating efficiency (η_{WH}), average climate	%	120			120			120		
COP _{DHW} , average climate	-	2.74			2.74			2.74		
Water heating eff. class, average climate	-	A+			A+			A+		
Annual energy consumption, DHW (average climate)	kWh				850					
Heating up time acc. to EN 16147 (average climate)	h/mn				1h25					
Max. usable water volume acc. to EN 16147 (average climate)	l				222					
Declared load profile, warmer climate	-	L			L			L		
Water heating efficiency (η_{WH}), warmer climate	%	151			151			151		
COP _{DHW} , warmer climate	-	3.43			3.43			3.43		
Water heating eff. class, warmer climate	-	A++			A++			A++		
Declared load profile, colder climate	-	L			L			L		
Water heating efficiency (η_{WH}), colder climate	%	101			101			101		
COP _{DHW} , colder climate	-	2.34			2.34			2.34		
Water heating eff. class, colder climate	-	A			A			A		
Sound power level (outdoor unit)	Rated / low noise mode	dB(A)	61 / 60		62 / 60		63 / 60			
Sound pressure level at 5m (outdoor unit)	Rated / low noise mode	dB(A)	39 / 38		40 / 38		41 / 38			
Sound power level (indoor unit)	Rated	dB(A)			43					
Sound pressure level at 1m (indoor unit)	Rated	dB(A)			35					

Nominal Capacity and COP/EER

Air / water	Heating capacity / COP	kW / -	12.00 / 5.04	14.00 / 4.89	16.00 / 4.80
Air +7°C / water +35°C	Heating capacity / COP	kW / -	11.00 / 3.65	12.00 / 3.63	13.80 / 3.60
Air +2°C / water +35°C	Heating capacity / COP	kW / -	11.00 / 2.90	11.50 / 2.85	12.00 / 2.80
Air +7°C / water +55°C	Heating capacity / COP	kW / -	12.00 / 4.75	14.00 / 4.30	16.00 / 4.00
Air +35°C / water +18°C	Cooling capacity / EER	kW / -	12.00 / 2.70	14.00 / 2.60	16.00 / 2.50
Air +35°C / water +7°C	Cooling capacity / EER	kW / -			

Note

1. Due to our policy of innovation, some specifications may be changed without notification.
2. Wiring cable size must comply with the applicable local and national codes. Especially the power cable and circuit breaker should be selected in accordance with that.
3. Sound power level is measured on the rated condition in accordance with ISO 9614 standard. Sound pressure level is not a value declared on Eurovent Program and is converted from sound power level based on a tonality penalty of 0 dB and installation in free-field. The directivity index (Q) is assumed as 2. Therefore, these values can be increased owing to ambient conditions during operation. Rated sound power level is in accordance with EN12102-1 under condition of EN14825.
4. Performances are in accordance with EN14511 and reflect ErP testing conditions. Above gives the declared values at rated conditions according to ErP regulation.
5. This product contains fluorinated greenhouse gases.
6. All installation sites must be equipped with an earth leakage circuit breaker (ELCB).
7. DHW 55 ~ 80°C Operating is available only when the booster heater is operating.

R32 HYDROSPLIT COMBI UNIT

Product Specification

Outdoor Units		Unit	HU121MRB U30 HU123MRB U30	HU141MRB U30 HU143MRB U30	HU161MRB U30 HU163MRB U30
Operation range (outdoor air temperature)	Heating & DHW (Min. ~ Max.)	°C	-25 ~ 35		
	Cooling (Min. ~ Max.)	°C	5 ~ 48		
Refrigerant	Type	-	R32		
	GWP	-	675		
	Precharged amount	g	2,100		
Piping connections (water)	Inlet / outlet diameter	inch	Male PT 1" according to ISO 7-1 (tapered pipe threads)		
Dimension	H x W x D	mm	1,380 x 950 x 330		
Weight	Empty	kg	91.7		
Exterior	Color / RAL code	-	Warm gray / RAL 7044		
Power supply	Voltage, phase, frequency	V, Ø, Hz	220 - 240, 1, 50 / 380 - 415, 3, 50		
	Standby power consumption	W	60		
	Recommended circuit breaker	A	40 / 16		

Indoor Units		Unit	HN1616Y NB1
Operation range (leaving water temperature)	Heating (Min. ~ Max.)	°C	15 ~ 65
	Cooling (Min. ~ Max.)	°C	5 ~ 27
	DHW (Min. ~ Max.)	°C	15 ~ 80
Domestic hot water tank	Volume	ℓ	200
	Tank material	-	Enameled steel
	Standby losses		61
Expansion vessel (heating circuit)	Volume	ℓ	12
Electric heater (Case 1 / Case 2 / Case 3) 4)	Capacity combination	kW	2.0 / 2.0 + 2.0 / 2.0 + 2.0 + 2.0
	Heating steps	Steps	1
	Power supply	V, Ø, Hz	220 - 240, 1, 50 / 220 - 240, 1, 50 / 380 - 415, 3, 50
	Rated running current	A	8.7 / 17.4 / 8.7
Piping connections (water)	Outlet to outdoor unit	inch	Female G1" according to ISO228-1 (parallel pipe threads)
	Inlet from outdoor unit	inch	
	Outlet to heat load	inch	
	Inlet from heat load	inch	Female G3/4" according to ISO228-1 (parallel pipe threads)
	Inlet / outlet diameter for DHW Recirculation	inch	
Dimension	H x W x D	mm	1,812 x 601 x 685
Weight	Empty	kg	130.0
Exterior	Color / RAL code	-	White / RAL 9002

Note

- Due to our policy of innovation, some specifications may be changed without notification.
- Wiring cable size must comply with the applicable local and national codes. Especially the power cable and circuit breaker should be selected in accordance with that.
- Sound power level is measured on the rated condition in accordance with ISO 9614 standard. Sound pressure level is converted from sound power level based on a tonality penalty of 0 dB and installation in free-field. The directivity index (Q) is assumed as 2. Therefore, these values can be increased owing to ambient conditions during operation. Rated sound power level is in accordance with EN12102-1 under condition of EN14825.
- Performances are in accordance with EN14511 and reflect ErP testing conditions. Above gives the declared values at rated conditions according to ErP regulation.
- This product contains fluorinated greenhouse gases.
- All installation sites must be equipped with an earth leakage circuit breaker (ELCB).
- DHW 55 ~ 80°C Operating is available only when the booster heater is operating.

Accessory Parts (Optional Accessory)

Buffer tank for space heating

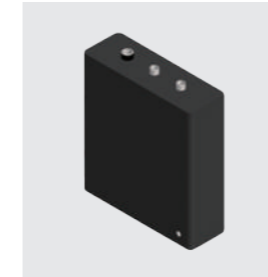

A standard 40 ℓ buffer tank for can be installed as an optional accessory for space heating. Fitting seamlessly into the main casing, it can be attached to the backside of the indoor unit.

Electrical specification		Unit	OSHB-40KT.AEU
Water volume		ℓ	40
Dimensions (H x W x D)		mm	560 x 518 x 175
Weight (w/o water)	Product	kg	24

* The buffer tank for space heating should be purchased and installed separately.

Expansion vessel for DHW



A standard 8 ℓ DHW expansion vessel, that conveniently fits inside the indoor unit, can be installed as an optional accessory. It is provided with an accessory kit that includes a flexible connection tube.

Electrical specification		Unit	OSHE-12KT.AEU
Water volume		ℓ	8
Connection		inch	3/4
Max. pressure		bar	10
Pre-charge		bar	3
Dimensions (H x W x D)		mm	238 x 416 x 502
Weight (w/o water)	Product	kg	2.5

* The expansion vessel for DHW should be purchased and installed separately.

Supplied Parts

Shut-off valve



Shut-off valve with strainer



Strainer

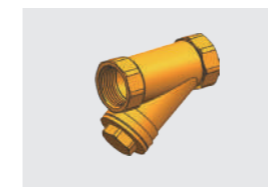

Technical specification		Details	
Material	Body	Brass	
	Mesh	Stainless steel (STS304)	
Mesh	Mesh no.	30	
	Max. particle size	0.6 mm	
Piping connection		Female G 1" according to ISO 228-1	

* The strainer and valves are supplied with the product, but it need to be installed separately.

* This strainer should be installed at the inlet connection of the outdoor unit to protect the clogging of a plate heat exchanger.

R32 HYDROSPLIT COMBI UNIT

Performance Table for Heating Operation

Maximum heating capacity (including defrost effect)

HU121MRB U30 / HU123MRB U30 + HN1616Y NB1

Outdoor Temperature	Capacity (kW)							
	LWT 30 °C	LWT 35 °C	LWT 40 °C	LWT 45 °C	LWT 50 °C	LWT 55 °C	LWT 60 °C	LWT 65 °C
-25°C DB	9.66	8.85	8.42	8.29	-	-	-	-
-20°C DB	10.13	10.00	9.88	9.75	9.63	-	-	-
-15°C DB	11.50	11.50	11.50	11.50	11.50	11.50	-	-
-7°C DB	12.00	12.00	12.00	12.00	12.00	12.00	12.00	-
-4°C DB	12.00	12.00	12.00	12.00	12.00	12.00	12.00	12.00
-2°C DB	12.00	12.00	12.00	12.00	12.00	12.00	12.00	12.00
2°C DB	12.00	12.00	12.00	12.00	12.00	12.00	12.00	12.00
7°C DB	12.00	12.00	12.00	12.00	12.00	12.00	12.00	12.00
10°C DB	12.00	12.00	12.00	12.00	12.00	12.00	12.00	12.00
15°C DB	12.00	12.00	12.00	12.00	12.00	12.00	12.00	12.00
18°C DB	12.00	12.00	12.00	12.00	12.00	12.00	12.00	12.00
20°C DB	12.00	12.00	12.00	12.00	12.00	12.00	12.00	12.00
35°C DB	12.00	12.00	12.00	12.00	12.00	12.00	12.00	12.00

HU141MRB U30 / HU143MRB U30 + HN1616Y NB1

Outdoor Temperature	Capacity (kW)							
	LWT 30 °C	LWT 35 °C	LWT 40 °C	LWT 45 °C	LWT 50 °C	LWT 55 °C	LWT 60 °C	LWT 65 °C
-25°C DB	10.04	9.21	8.76	8.62	-	-	-	-
-20°C DB	11.82	11.25	10.95	10.67	10.59	-	-	-
-15°C DB	12.52	12.90	13.26	12.88	12.81	12.63	-	-
-7°C DB	14.00	14.00	14.00	14.00	14.00	14.00	14.00	-
-4°C DB	14.00	14.00	14.00	14.00	14.00	14.00	14.00	14.00
-2°C DB	14.00	14.00	14.00	14.00	14.00	14.00	14.00	14.00
2°C DB	14.00	14.00	14.00	14.00	14.00	14.00	14.00	14.00
7°C DB	14.00	14.00	14.00	14.00	14.00	14.00	14.00	14.00
10°C DB	14.00	14.00	14.00	14.00	14.00	14.00	14.00	14.00
15°C DB	14.00	14.00	14.00	14.00	14.00	14.00	14.00	14.00
18°C DB	14.00	14.00	14.00	14.00	14.00	14.00	14.00	14.00
20°C DB	14.00	14.00	14.00	14.00	14.00	14.00	14.00	14.00
35°C DB	14.00	14.00	14.00	14.00	14.00	14.00	14.00	14.00

HU161MRB U30 / HU163MRB U30 + HN1616Y NB1

Outdoor Temperature	Capacity (kW)							
	LWT 30 °C	LWT 35 °C	LWT 40 °C	LWT 45 °C	LWT 50 °C	LWT 55 °C	LWT 60 °C	LWT 65 °C
-25°C DB	10.98	10.00	9.50	9.33	-	-	-	-
-20°C DB	13.43	12.54	12.03	11.78	11.47	-	-	-
-15°C DB	14.23	14.39	14.50	13.95	13.86	13.12	-	-
-7°C DB	16.00	16.00	16.00	16.00	16.00	16.00	16.00	-
-4°C DB	16.00	16.00	16.00	16.00	16.00	16.00	16.00	16.00
-2°C DB	16.00	16.00	16.00	16.00	16.00	16.00	16.00	16.00
2°C DB	16.00	16.00	16.00	16.00	16.00	16.00	16.00	16.00
7°C DB	16.00	16.00	16.00	16.00	16.00	16.00	16.00	16.00
10°C DB	16.00	16.00	16.00	16.00	16.00	16.00	16.00	16.00
15°C DB	16.00	16.00	16.00	16.00	16.00	16.00	16.00	16.00
18°C DB	16.00	16.00	16.00	16.00	16.00	16.00	16.00	16.00
20°C DB	16.00	16.00	16.00	16.00	16.00	16.00	16.00	16.00
35°C DB	16.00	16.00	16.00	16.00	16.00	16.00	16.00	16.00

Note

- DB : Dry Bulb Temperature (°C), LWT : Leaving Water Temperature (°C), LPM : Liters Per Minute (l/min), TC : Total Capacity (kW)
- Direct interpolation is permissible. Do not extrapolate.
- Measuring procedure follows EN-14511.
 - Rated values are based on standard conditions and it can be found on specifications.
 - Above table values may not be matched according to installation condition. Except for rated value, the performance is not guaranteed.
 - In accordance with the test standard (or nations), the rating will vary slightly.
- The shaded areas are not guaranteed continuous operation.

Performance Table for Cooling Operation

Maximum cooling capacity

HU121MRB U30 / HU123MRB U30 + HN1616Y NB1

Outdoor Temperature	Capacity (kW)						
	LWT 7 °C	LWT 10 °C	LWT 13 °C	LWT 15 °C	LWT 18 °C	LWT 20 °C	LWT 22 °C
10°C DB	12.00	12.00	12.00	12.00	12.00	12.00	12.00
20°C DB	12.00	12.00	12.00	12.00	12.00	12.00	12.00
30°C DB	12.00	12.00	12.00	12.00	12.00	12.00	12.00
35°C DB	12.00	12.00	12.00	12.00	12.00	12.00	12.00
40°C DB	11.75	12.00	12.00	12.00	12.00	12.00	12.00
45°C DB	11.50	12.00	12.00	12.00	12.00	12.00	12.00

HU141MRB U30 / HU143MRB U30 + HN1616Y NB1

Outdoor Temperature	Capacity (kW)						
	LWT 7 °C	LWT 10 °C	LWT 13 °C	LWT 15 °C	LWT 18 °C	LWT 20 °C	LWT 22 °C
10°C DB	14.00	14.00	14.00	14.00	14.00	14.00	14.00
20°C DB	14.00	14.00	14.00	14.00	14.00	14.00	14.00
30°C DB	14.00	14.00	14.00	14.00	14.00	14.00	14.00
35°C DB	14.00	14.00	14.00	14.00	14.00	14.00	14.00
40°C DB	13.75	14.00	14.00	14.00	14.00	14.00	14.00
45°C DB	13.50	14.00	14.00	14.00	14.00	14.00	14.00

HU161MRB U30 / HU163MRB U30 + HN1616Y NB1

Outdoor Temperature	Capacity (kW)						
	LWT 7 °C	LWT 10 °C	LWT 13 °C	LWT 15 °C	LWT 18 °C	LWT 20 °C	LWT 22 °C
10°C DB	16.00	16.00	16.00	16.00	16.00	16.00	16.00
20°C DB	16.00	16.00	16.00	16.00	16.00	16.00	16.00
30°C DB	16.00	16.00	16.00	16.00	16.00	16.00	16.00
35°C DB	16.00	16.00	16.00	16.00	16.00	16.00	16.00
40°C DB	15.75	16.00	16.00	16.00	16.00	16.00	16.00
45°C DB	15.50	16.00	16.00	16.00	16.00	16.00	16.00

Note

- DB : Dry Bulb Temperature (°C), LWT : Leaving Water Temperature (°C), LPM : Liters Per Minute (l/min), TC : Total Capacity (kW)
- Direct interpolation is permissible. Do not extrapolate.
- Measuring procedure follows EN-14511.
 - Rated values are based on standard conditions and it can be found on specifications.
 - Above table values may not be matched according to installation condition. Except for rated value, the performance is not guaranteed.
 - In accordance with the test standard (or nations), the rating will vary slightly.
- The shaded areas are not guaranteed continuous operation.

R32 HYDROSPLIT COMBI UNIT

Drawings

HU121MRB U30 / HU141MRB U30 / HU161MRB U30
 HU123MRB U30 / HU143MRB U30 / HU163MRB U30

[Unit: mm]

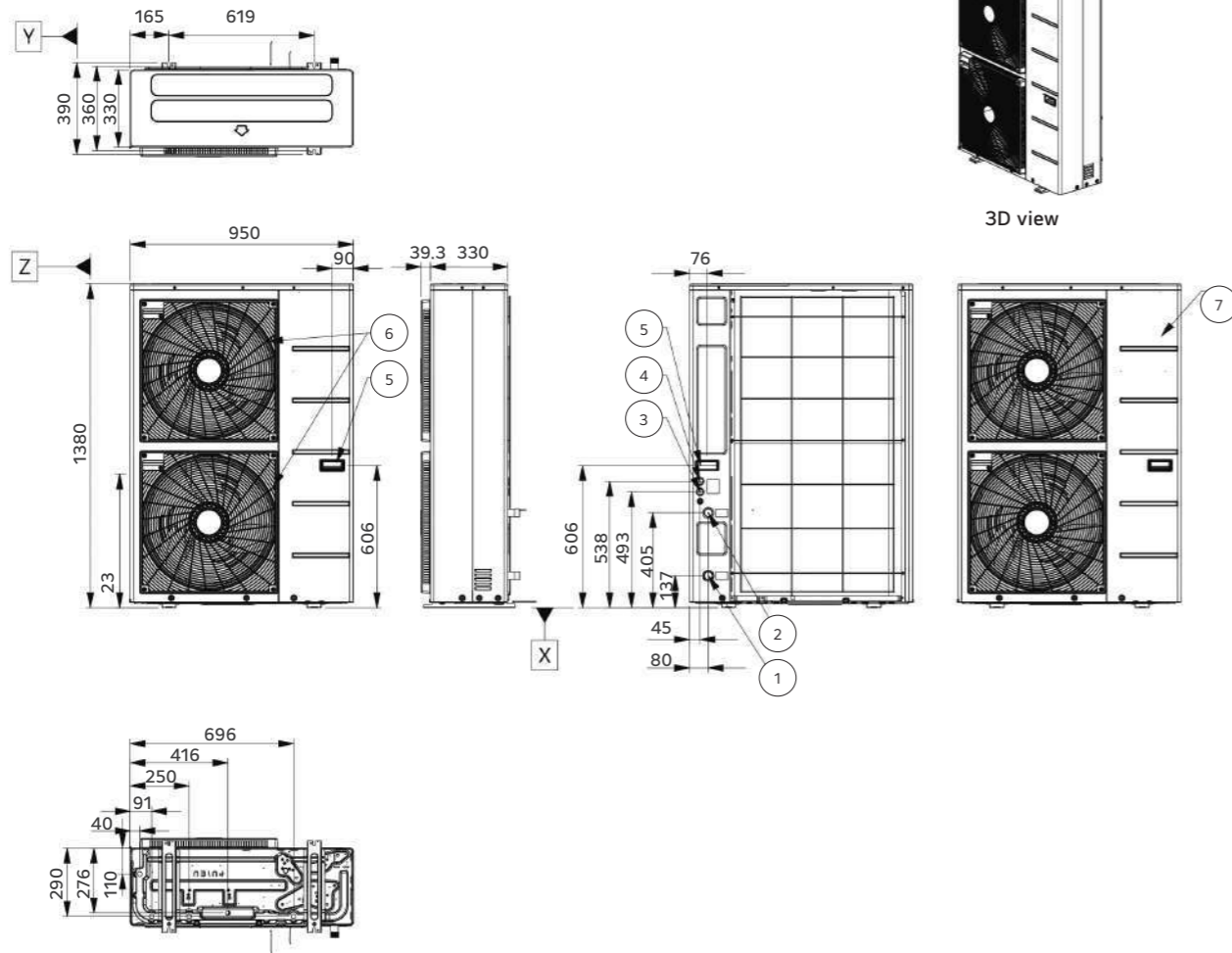

No.	Part name	Description
1	Entering water pipe	Male PT 1" according to ISO 7-1 (tapered pipe threads)
2	Leaving water pipe	Male PT 1" according to ISO 7-1 (tapered pipe threads)
3	Unit power	Power cable hole
4	Low voltage	Communication cable hole
5	Handle	-
6	Air outlet	-
7	Side panel	-

HN1616Y NB1

[Unit: mm]

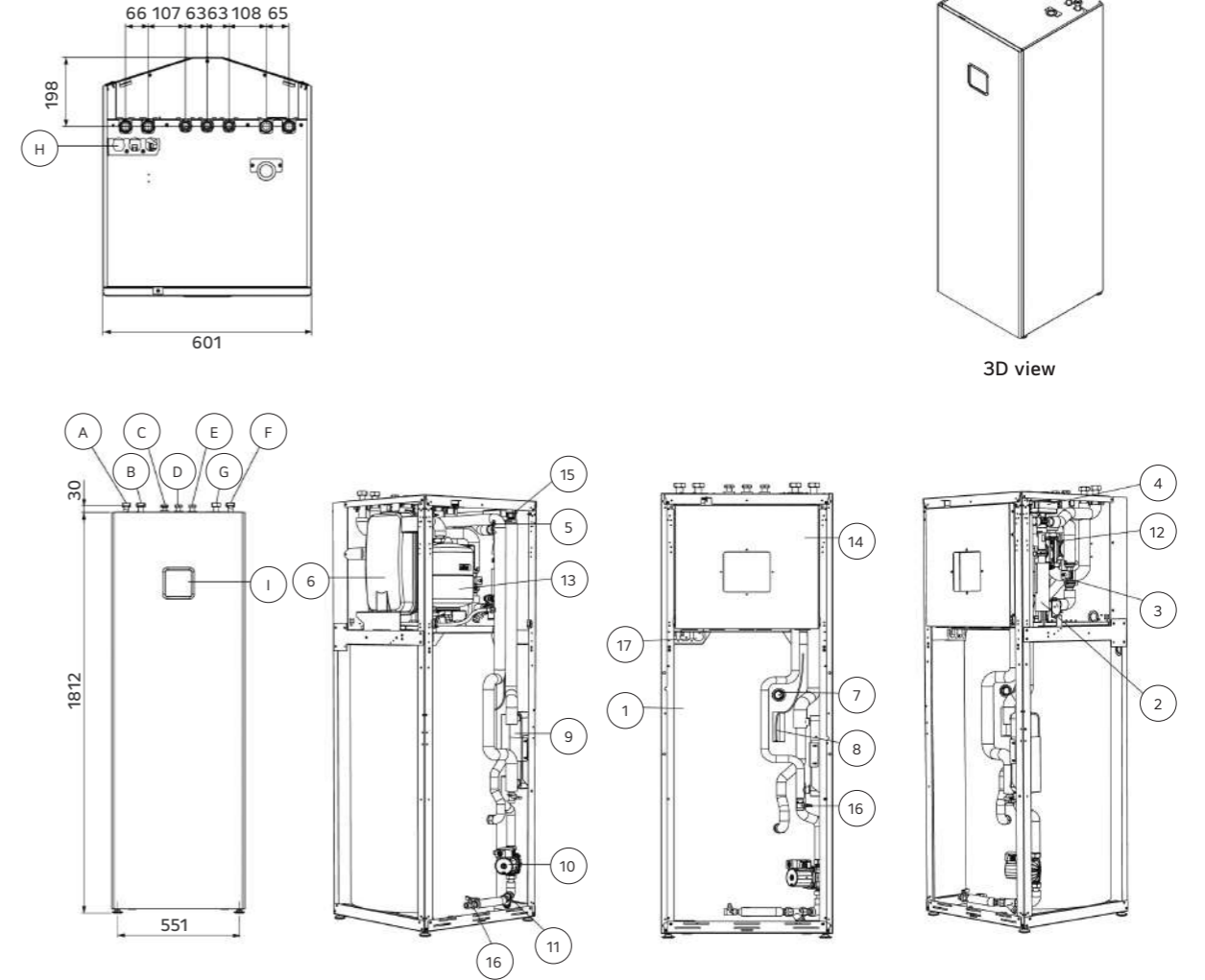

No.	Part name	Description
1	Domestic hot water tank	200 ℓ
2	Electric heater	Max 6 kW
3	Flow sensor	To measure the water flow rate (5-80 LPM)
4	3 way valve	Heating / DHW circuit
5	Water pressure sensor	To measure the water pressure (0-2 MPa)
6	Expansion vessel	12 ℓ for heating circuit
7	Magnesium anode	To prevent corrosion
8	DHW tank sensor	Temperature sensor
9	Plate heat exchanger	Heat exchange (water / DHW tank)
10	DHW charging pump	To circulate water for DHW heating
11	Strainer for DHW tank	Filtering and stacking particles
12	Main water pump	To circulate water inside the system
13	Expansion vessel	8 ℓ For DHW circuit (accessory)
14	Control box	PCB and terminal blocks
15	Air vent	Air purging when charging water
16	Drain cock	Valve for water draining
17	Electrical conduits	For electric wiring

No.	Part name	Description
A	Inlet pipe from outdoor unit	Female G1"
B	Outlet pipe to outdoor unit	Female G1"
C	Domestic hot water outlet pipe	Female G3/4"
D	Domestic cold water inlet pipe	Female G3/4"
E	Domestic re-circulation pipe	Female G3/4"
F	Heating circuit outlet pipe	Female G1"
G	Heating circuit inlet pipe	Female G1"
H	Electrical conduits	For electric wiring
I	Control panel	Built-in remote controller

THERMA V™

R32 Split Hydro Unit



Effortless Installation, Cold-Weather Resilience

What is R32 Split Hydro Unit

The LG THERMA V Split series is a heat pump that is easy, flexible to install. As the expression "split" suggests, the outdoor and indoor units are connected by refrigerant piping, thus freezing will not compromise this unit regardless of outdoor ambient temperatures.

THERMA V Split Hydro Unit is a combination of an outdoor unit and an indoor Hydro Unit with built-in hydronic components such as a plate heat exchanger, expansion tank and water pump.

The outdoor unit is on offer in 4/6 kW and 5/7/9 kW capacity range. R32 Split 4/6 kW model is suitable for new build houses that are well insulated and require a small heating load, while R32 Split 5/7/9 kW model is adapted for both new build and renovation projects.

Product Range

Phase	Capacity (kW)	Indoor Unit	Outdoor Unit
1 Ø	4	HN0613M NK5	HU041MR U20
	6		HU061MR U20
	5	HN091MR NK5	HU051MR U44
	7		HU071MR U44
	9		HU091MR U44



Key Features

- Capacity range from 4 and 6 kW for new build and 5 to 9 kW for new build or small renovation
- R32 refrigerant with reduced Global Warming Potential (GWP)
- Maximum flow temperature up to 55°C (4/6 kW) and 65°C (5/7/9 kW)
- Operation range down to -20°C (4/6 kW) and -25°C (5/7/9 kW)
- High level hydronic components integration for fast and clean installation

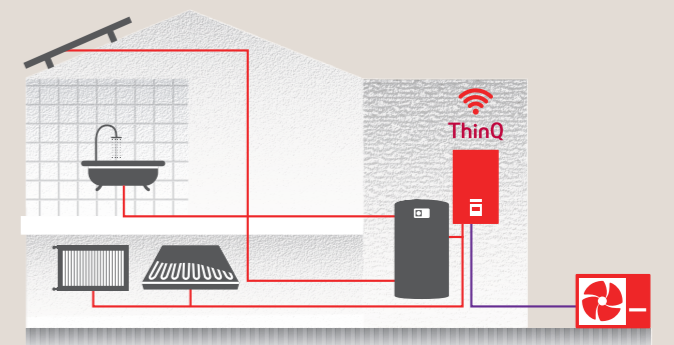

Excellent performance & efficiency

- R32 refrigerant
- R1 Compressor (5/7/9kW only)
- Flash gas injection
- Wide operation range
- Black Fin heat exchanger
- Solar thermal
- Energy state
- Modbus connectivity

User convenience

- Intuitive interface
- LG ThinQ
- 2nd circuit
- Various control options
- Seasonal auto mode
- 3rd party boiler
- Energy monitoring
- DHW recirculation
- Low noise mode
- Advanced pump control options
- 2 remote control

Easy installation & maintenance

- Small refrigerant amount
- Light weight
- Flexible piping design (5/7/9kW only)
- LG BECON cloud
- Clip connection

THERMA V™ R32

HIGHLIGHT OF R32 SPLIT HYDRO UNIT



Browse now

No Potential Risk of Piping Freezing

- Robust to cold ambient thanks to refrigerant piping
- No exposed piping freezing even during prolonged blackouts



High Installation Flexibility Not Restricted by the Site Condition

- Light weight and compact size
- Allows a maximum refrigerant pipe length of 50 m and offers 3-way piping connection availability (R32 Split 5/7/9 kW Split)
- Eliminates minimum floor area requirements due to R32 refrigerant (R32 Split 4/6 kW)



Reduced Noise Level

ONLY 4/6 kW

The R32 Split outdoor unit can be installed at the minimum of 4.5 m away¹⁾ from neighboring houses while complying with noise-related requirements in most European countries, including Germany. (based on 4 kW ODU & low noise mode)

Description		Germany	Austria	Switzerland	Netherlands
Sound pressure threshold	Day time	50 dB (A) (06:00 - 22:00)	40 dB (A) (06:00 - 19:00)	40 dB (A) (07:00 - 19:00)	45 dB (A) (07:00 - 19:00)
	Evening	-	35 dB (A) (19:00 - 22:00)	-	-
	Night time	35 dB (A) (22:00 - 06:00)	30 dB (A) (22:00 - 06:00)	35 dB (A) (19:00 - 07:00)	40 dB (A) (19:00 - 07:00)

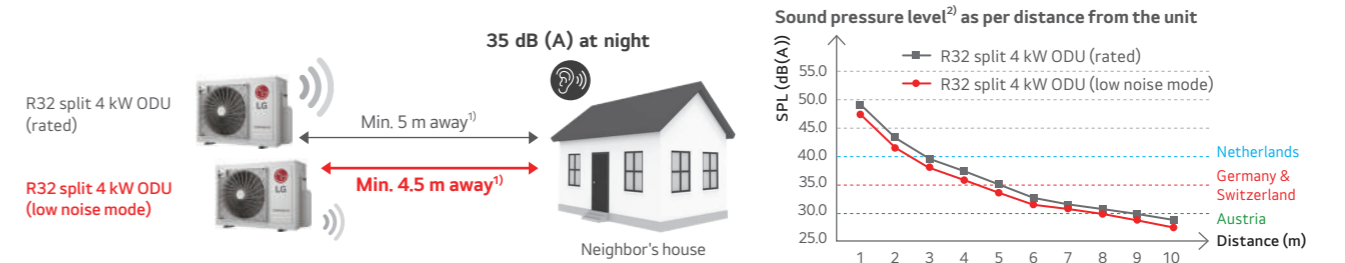

1) Minimum distance to be away from a neighboring property may vary depending on installation conditions and noise regulations in individual countries.
2) Sound pressure level is converted from sound power level of low noise mode based on a tonality penalty of 0 dB and installation in free-field. The directivity index (Q) is assumed as 2.

Small Refrigerant Amount

- free from minimum floor area requirements due to R32 refrigerant

ONLY 4/6 kW

Minimum floor space requirements do not apply to R32 Split 4/6 kW, as the maximum refrigerant amount (including 30 m pipes) used in the product is smaller than the minimum set by regulation. As a result, there are more opportunities for flexible design and installation.

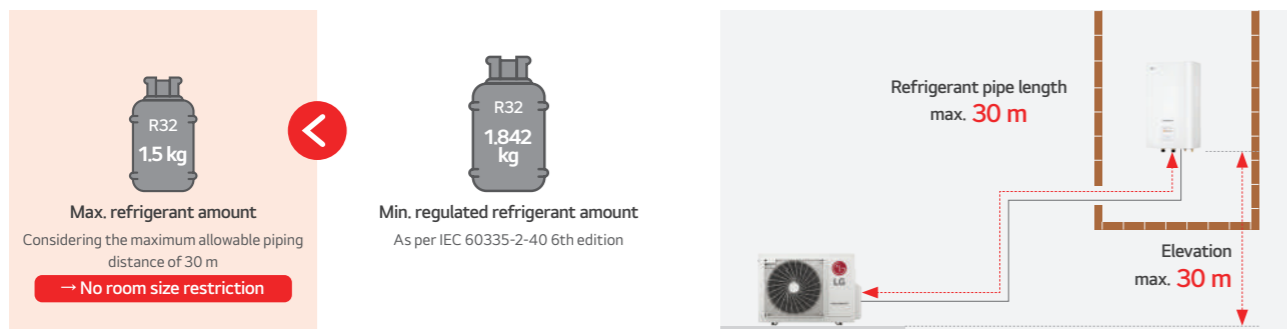

Flexible Refrigerant Piping Design

ONLY 5/7/9 kW

Installation flexibility is enabled by THERMA V Split's long pipe length (up to 50 m) and the fact that the refrigerant piping can be connected in three directions: front, side and rear.

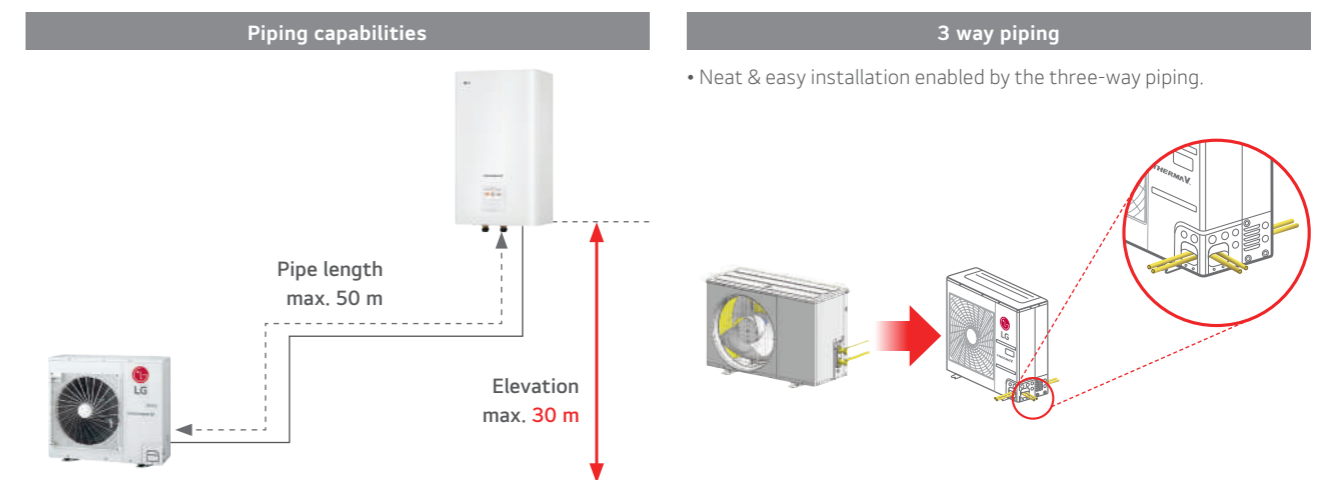

THERMA V™ R32

R32 SPLIT HYDRO UNIT (4 / 6 kW)

Outdoor unit
HU041MR U20
HU061MR U20

Indoor unit
HN0613M NK5

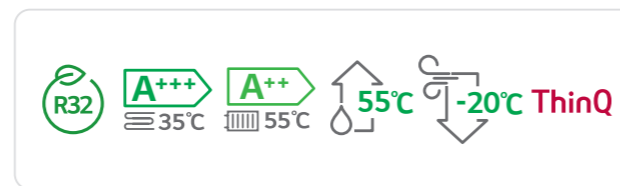

Key Components

Hydro Unit

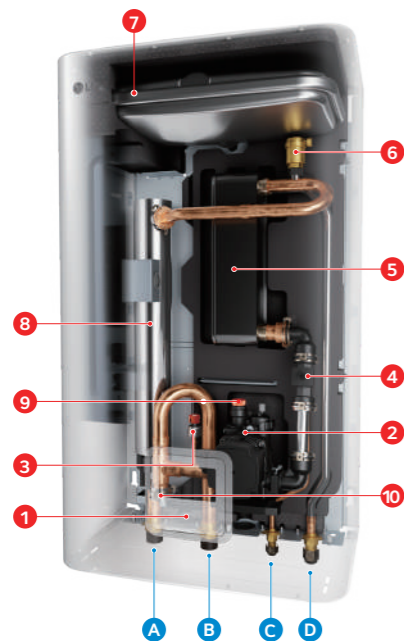

Components

- 1 Standard III remote controller¹⁾
(air temp. sensor integrated)
- 2 Water pump
- 3 Water pressure sensor
- 4 Flow sensor
- 5 Plate type heat exchanger (ref./water)
- 6 Air vent valve
- 7 Expansion vessel (8 ℓ)
- 8 Back up electric heater (3 kW)
- 9 Safety valve
- 10 Strainer

1) Temperature control class (ERP class) : V

Connections

- A Heating circuit outlet pipe (male PT 1" *)
- B Heating circuit inlet pipe (male PT 1" *)
- C Refrigerant liquid pipe (SAE 1/4" with connector **)
- D Refrigerant gas pipe (SAE 1/2" with connector **)

* According to ISO 7-1 (tapered pipe threads)

** In case of Split 4/6 kW model, the adaptors provided with the outdoor unit must be separately installed on the gas/liquid connection of the indoor unit when connecting the refrigerant pipe. After installing the adaptors, the liquid and gas connection size becomes Ø 6.35 (1/4 inch) and Ø 12.7 (1/2 inch) respectively.

Product Specification

Efficiency Data	Unit	4 kW (1 Ø)	6 kW (1 Ø)
Seasonal space heating eff. class (35°C / 55°C)	-	A+++ / A++	A+++ / A++
Seasonal space heating efficiency (η _s) (35°C / 55°C)	%	183 / 126	183 / 126
SCOP (35°C / 55°C)	-	4.65 / 3.23	4.65 / 3.23
Sound power level (outdoor unit)	Rated / low noise mode	57 / 56	58 / 57
Sound pressure level at 5m (outdoor unit)	Rated / low noise mode	35 / 34	36 / 35
Sound power level (indoor unit)	Rated	44	
Sound pressure level at 1m (indoor unit)	Rated	36	

Nominal Capacity and COP/EER

Air / water	Heating capacity / COP	Unit	4 kW / 5.10	6 kW / 4.95
Air +7°C / water +35°C	Heating capacity / COP	kW / -	4.00 / 5.10	6.00 / 4.95
Air +2°C / water +35°C	Heating capacity / COP	kW / -	3.60 / 3.75	4.80 / 3.65
Air -7°C / water +35°C	Heating capacity / COP	kW / -	4.00 / 3.08	6.00 / 2.98
Air +7°C / water +55°C	Heating capacity / COP	kW / -	3.70 / 2.85	4.60 / 2.90
Air -7°C / water +55°C	Heating capacity / COP	kW / -	3.70 / 1.80	4.60 / 1.80
Air +35°C / water +18°C	Cooling capacity / EER	kW / -	4.00 / 4.80	6.00 / 4.80
Air +35°C / water +7°C	Cooling capacity / EER	kW / -	4.00 / 3.40	6.00 / 3.20

Outdoor Units	Unit	HU041MR U20	HU061MR U20
Operation range (outdoor air temperature)	Heating & DHW (Min. - Max.)	-20 ~ 35	
	Cooling (Min. - Max.)	5 ~ 48	
Refrigerant	Type	R32	
	GWP	675	
Piping connections (water)	Precharged amount	1,100	
	Gas / Liquid	Ø 12.7 (1/2) / Ø 6.35 (1/4)	
	Length standard / Max.	5 / 30	
	Level difference Max.	30	
	Max. length without additional charge	10	
	Mass of additional ref. charge	20	
Dimension	H x W x D	650 x 870 x 330	
Weight	Empty	44.7	
Exterior	Color / RAL code	Warm gray / RAL 7044	
	Voltage, phase, frequency	220 - 240, 1, 50	
Power supply	Standby power consumption	20	
	Recommended circuit breaker	A	
		16	20

Indoor Units	Unit	HN0613M NK5
Operation range (leaving water temperature)	Heating (Min. - Max.)	15 ~ 55
	Cooling (Min. - Max.)	5 ~ 27
	DHW (Min. - Max.)	15 ~ 80
Expansion vessel (heating circuit)	Volume	8
	Capacity combination	1.5 + 1.5
Backup heater	Heating steps	2
	Power supply	220 - 240, 1, 50
	Rated running current	13.0
Piping connections (water)	Inlet / outlet diameter	Male PT 1" according to ISO 7-1 (tapered pipe threads)
Piping connections (ref.)	Gas / Liquid	Ø 12.7 (1/2) / Ø 6.35 (1/4)
Dimension	H x W x D	850 x 490 x 315
Weight	Empty	37.8
Exterior	Color / RAL code	Noble white / RAL 9016

Note

1. Due to our policy of innovation, some specifications may be changed without notification.
2. Wiring cable size must comply with the applicable local and national codes. Especially the power cable and circuit breaker should be selected in accordance with that.
3. Sound power level is measured on the rated condition in accordance with ISO 9614 standard. Sound pressure level is not a value declared on Eurovent Program and is converted from sound power level based on a tonality penalty of 0 dB and installation in free-field. The directivity index (Q) is assumed as 2. Therefore, these values can be increased owing to ambient conditions during operation. Rated sound power level is in accordance with EN12102-1 under condition of EN14825.
4. Performances are in accordance with EN14511 and reflect ErP testing conditions. Above gives the declared values at rated conditions according to ErP regulation.
5. This product contains fluorinated greenhouse gases.
6. All installation sites must be equipped with an earth leakage circuit breaker (ELCB).
7. DHW 50 ~ 80°C Operating is available only when the booster heater is operating.

R32 SPLIT HYDRO UNIT (4 / 6 kW)

Performance Table for Heating Operation

Maximum heating capacity (including defrost effect)

HU041MR U20 + HN0613M NK5

Outdoor Temperature	Capacity (kW)					
	LWT 30 °C	LWT 35 °C	LWT 40 °C	LWT 45 °C	LWT 50 °C	LWT 55 °C
-20°C DB	4.00	4.00	4.00	4.00	-	-
-15°C DB	4.00	4.00	4.00	4.00	4.00	-
-7°C DB	4.00	4.00	4.00	4.00	4.00	4.00
-4°C DB	4.00	4.00	4.00	4.00	4.00	4.00
-2°C DB	4.00	4.00	4.00	4.00	4.00	4.00
2°C DB	4.00	4.00	4.00	4.00	4.00	4.00
7°C DB	4.00	4.00	4.00	4.00	4.00	4.00
10°C DB	4.00	4.00	4.00	4.00	4.00	4.00
15°C DB	4.00	4.00	4.00	4.00	4.00	4.00
18°C DB	4.00	4.00	4.00	4.00	4.00	4.00
20°C DB	4.00	4.00	4.00	4.00	4.00	4.00
35°C DB	4.00	4.00	4.00	4.00	4.00	4.00

HU061MR U20 + HN0613M NK5

Outdoor Temperature	Capacity (kW)					
	LWT 30 °C	LWT 35 °C	LWT 40 °C	LWT 45 °C	LWT 50 °C	LWT 55 °C
-20°C DB	4.92	4.78	4.64	4.50	-	-
-15°C DB	5.56	5.52	5.48	5.44	5.40	-
-7°C DB	6.00	6.00	6.00	6.00	6.00	6.00
-4°C DB	6.00	6.00	6.00	6.00	6.00	6.00
-2°C DB	6.00	6.00	6.00	6.00	6.00	6.00
2°C DB	6.00	6.00	6.00	6.00	6.00	6.00
7°C DB	6.00	6.00	6.00	6.00	6.00	6.00
10°C DB	6.00	6.00	6.00	6.00	6.00	6.00
15°C DB	6.00	6.00	6.00	6.00	6.00	6.00
18°C DB	6.00	6.00	6.00	6.00	6.00	6.00
20°C DB	6.00	6.00	6.00	6.00	6.00	6.00
35°C DB	6.00	6.00	6.00	6.00	6.00	6.00

Note

- DB : Dry Bulb Temperature (°C), LWT : Leaving Water Temperature (°C), LPM : Liters Per Minute (l/min), TC : Total Capacity (kW)
- Direct interpolation is permissible. Do not extrapolate.
- Measuring procedure follows EN-14511.
 - Rated values are based on standard conditions and it can be found on specifications.
 - Above table values may not be matched according to installation condition. Except for rated value, the performance is not guaranteed.
 - In accordance with the test standard (or nations), the rating will vary slightly.
- The shaded areas are not guaranteed continuous operation.

Performance Table for Cooling Operation

Maximum cooling capacity

HU041MR U20 + HN0613M NK5

Outdoor Temperature	Capacity (kW)						
	LWT 7 °C	LWT 10 °C	LWT 13 °C	LWT 15 °C	LWT 18 °C	LWT 20 °C	LWT 22 °C
10°C DB	4.00	4.00	4.00	4.00	4.00	4.00	4.00
20°C DB	4.00	4.00	4.00	4.00	4.00	4.00	4.00
30°C DB	4.00	4.00	4.00	4.00	4.00	4.00	4.00
35°C DB	4.00	4.00	4.00	4.00	4.00	4.00	4.00
40°C DB	4.00	4.00	4.00	4.00	4.00	4.00	4.00
45°C DB	4.00	4.00	4.00	4.00	4.00	4.00	4.00

HU061MR U20 + HN0613M NK5

Outdoor Temperature	Capacity (kW)						
	LWT 7 °C	LWT 10 °C	LWT 13 °C	LWT 15 °C	LWT 18 °C	LWT 20 °C	LWT 22 °C
10°C DB	6.00	6.00	6.00	6.00	6.00	6.00	6.00
20°C DB	6.00	6.00	6.00	6.00	6.00	6.00	6.00
30°C DB	6.00	6.00	6.00	6.00	6.00	6.00	6.00
35°C DB	6.00	6.00	6.00	6.00	6.00	6.00	6.00
40°C DB	5.74	5.81	5.87	5.91	6.00	6.00	6.00
45°C DB	5.48	5.61	5.73	5.81	5.94	6.00	6.00

Note

- DB : Dry Bulb Temperature (°C), LWT : Leaving Water Temperature (°C), LPM : Liters Per Minute (l/min), TC : Total Capacity (kW)
- Direct interpolation is permissible. Do not extrapolate.
- Measuring procedure follows EN-14511.
 - Rated values are based on standard conditions and it can be found on specifications.
 - Above table values may not be matched according to installation condition. Except for rated value, the performance is not guaranteed.
 - In accordance with the test standard (or nations), the rating will vary slightly.
- The shaded areas are not guaranteed continuous operation.

THERMAV™ R32 SPLIT HYDRO UNIT (4 / 6 kW)

Drawings

HU041MR U20 / HU061MR U20

[Unit: mm]

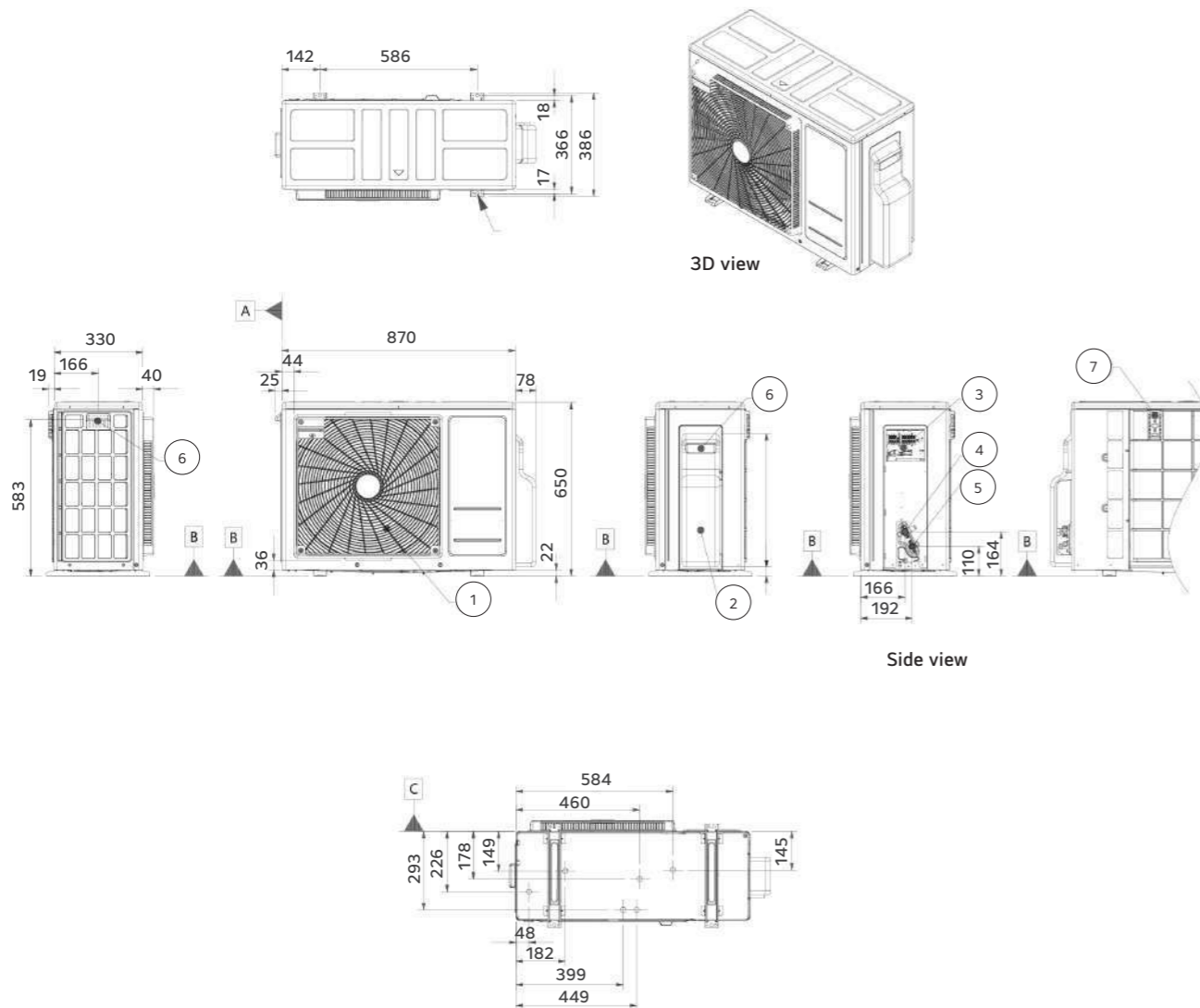

No.	Part name	Description
1	Air outlet	-
2	Control cover & SVC valve cover	-
3	Power and communication cable connection	-
4	Gas pipe connection	Flare joint
5	Liquid pipe connection	Flare joint
6	Handle	-
7	Intake air temperature sensor cover	-

HN0613M NK5

[Unit: mm]

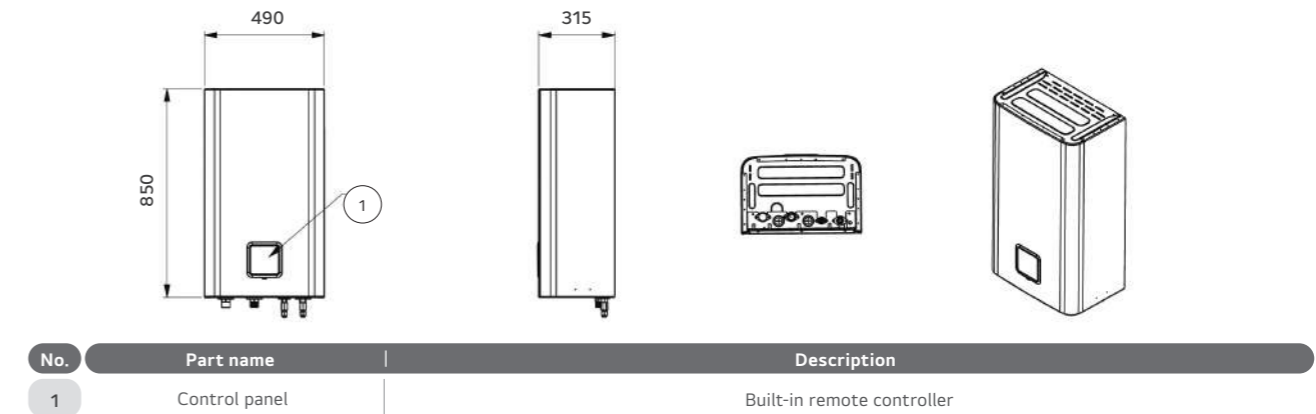

No.	Part name	Description
1	Control panel	Built-in remote controller

Internal

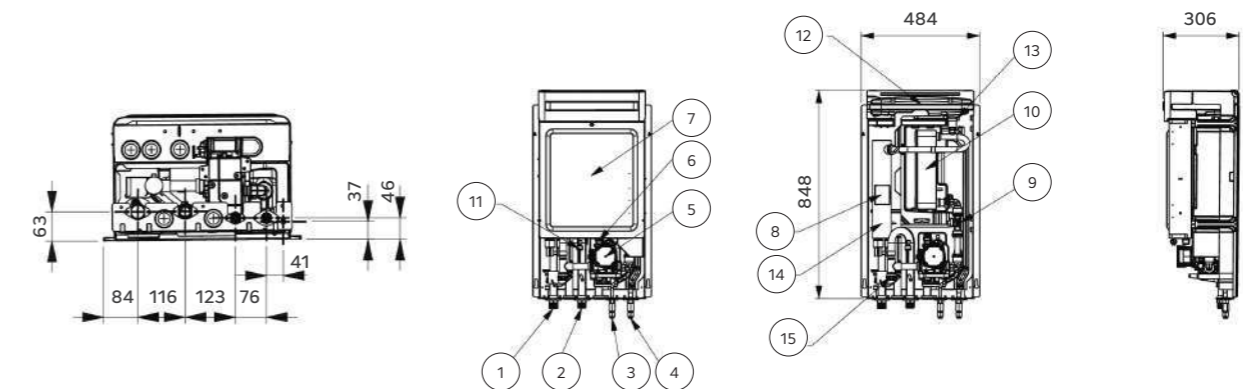

No.	Part name	Description
1	Leaving water pipe	Male PT 1" according to ISO 7-1 (tapered pipe threads)
2	Entering water pipe	Male PT 1" according to ISO 7-1 (tapered pipe threads)
3	Refrigerant piping connection	Ø 6.35 ¹⁾ (mm)
4	Refrigerant piping connection	Ø 12.7 ¹⁾ (mm)
5	Water pump	To circulate water inside the system
6	Safety valve	Open at water pressure 3 bar
7	Control box	PCB and terminal blocks
8	Thermostat	Cut-off power input to electric heater at 90°C
9	Flow sensor	To measure the water flow rate (5-80 LPM)
10	Plate heat exchanger	Heat exchange between refrigerant and water
11	Pressure sensor	To measure the water pressure (0-2 MPa)
12	Expansion tank	Absorbing volume change of heated water
13	Air vent	Air purging when charging water
14	Backup heater	3 kW
15	Strainer	Filtering and stacking particles inside circulating water

1) When connecting the refrigerant pipe, the adaptors provided with the outdoor unit must be installed on the connection of the indoor unit.

THERMA V™ R32

R32 SPLIT HYDRO UNIT (5 / 7 / 9 kW)

Outdoor unit
 HU051MR U44
 HU071MR U44
 HU091MR U44

Indoor unit
 HN091MR NK5

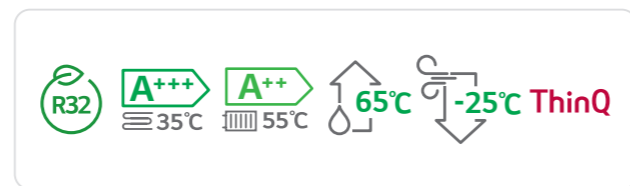

Key Components

Hydro Unit

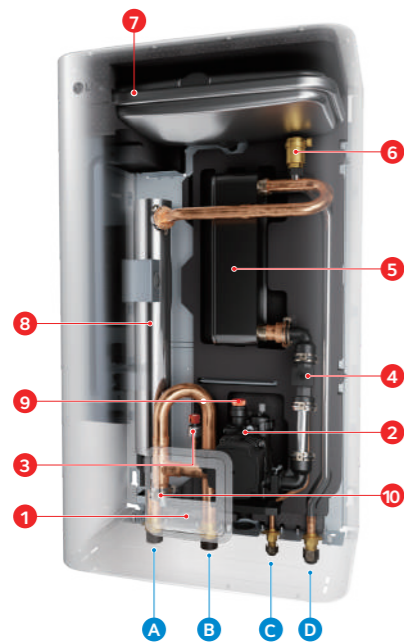

Components

- 1 Standard III remote controller¹⁾ (air temp. sensor integrated)
- 2 Water pump
- 3 Water pressure sensor
- 4 Flow sensor
- 5 Plate type heat exchanger (ref./water)
- 6 Air vent valve
- 7 Expansion vessel (8 ℓ)
- 8 Back up electric heater (3 kW)
- 9 Safety valve
- 10 Strainer

1) Temperature control class (ERP class) : V

Connections

- A Heating circuit outlet pipe (male PT 1" *)
- B Heating circuit inlet pipe (male PT 1" *)
- C Refrigerant liquid pipe (SAE 3/8")
- D Refrigerant gas pipe (SAE 5/8")

* According to ISO 7-1 (tapered pipe threads)

Product Specification

Efficiency Data	Unit	5 kW (1 Ø)	7 kW (1 Ø)	9 kW (1 Ø)
Seasonal space heating eff. class (35°C / 55°C)	-	A+++ / A++	A+++ / A++	A+++ / A++
Seasonal space heating efficiency (η _s) (35°C / 55°C)	%	183 / 126	183 / 126	183 / 126
SCOP (35°C / 55°C)	-	4.65 / 3.23	4.65 / 3.23	4.65 / 3.23
Sound power level (outdoor unit)	Rated / low noise mode	dB(A)		
Sound pressure level at 5m (outdoor unit)	Rated / low noise mode	dB(A)		
Sound power level (indoor unit)	Rated	dB(A)		
Sound pressure level at 1m (indoor unit)	Rated	dB(A)		

Nominal Capacity and COP/EER	Unit	5 kW (1 Ø)	7 kW (1 Ø)	9 kW (1 Ø)	
Air +7°C / water +35°C	Heating capacity / COP	kW / -	5.50 / 4.90	7.00 / 4.90	9.00 / 4.65
Air +2°C / water +35°C	Heating capacity / COP	kW / -	3.30 / 3.52	4.20 / 3.51	5.40 / 3.50
Air +7°C / water +55°C	Heating capacity / COP	kW / -	5.50 / 2.70	5.50 / 2.70	5.50 / 2.70
Air +35°C / water +18°C	Cooling capacity / EER	kW / -	5.50 / 4.60	7.00 / 4.50	9.00 / 4.20
Air +35°C / water +7°C	Cooling capacity / EER	kW / -	5.50 / 2.80	7.00 / 2.70	9.00 / 2.60

Outdoor Units	Unit	HU051MR U44	HU071MR U44	HU091MR U44
Operation range (outdoor air temperature)	Heating & DHW (Min. - Max.)	°C		
	Cooling (Min. - Max.)	°C		
Refrigerant	Type	R32		
	GWP	675		
	Precharged amount	1,500		
Piping connections (ref.)	Gas / Liquid	mm (inch)		
	Length standard / Min. / Max.	m		
	Level difference Max.	m		
	Max. length without additional charge	m		
	Mass of additional ref. charge	g/m		
Dimension	H x W x D	mm		
Weight	Empty	kg		
Exterior	Color / RAL code	Warm gray / RAL 7044		
	Voltage, phase, frequency	V, Ø, Hz		
Power supply	Standby power consumption	W		
	Recommended circuit breaker	A		
		20	25	30

Indoor Units	Unit	HN091MR NK5
Operation range (leaving water temperature)	Heating (Min. - Max.)	°C
	Cooling (Min. - Max.)	°C
	DHW (Min. - Max.)	°C
Expansion vessel (heating circuit)	Volume	ℓ
	Capacity combination	kW
Backup heater	Heating steps	Steps
	Power supply	V, Ø, Hz
	Rated running current	A
Piping connections (water)	Inlet / outlet diameter	inch
Piping connections (ref.)	Gas / Liquid	mm (inch)
Dimension	H x W x D	mm
Weight	Empty	kg
Exterior	Color / RAL code	-

Note

1. Due to our policy of innovation, some specifications may be changed without notification.
2. Wiring cable size must comply with the applicable local and national codes. Especially the power cable and circuit breaker should be selected in accordance with that.
3. Sound power level is measured on the rated condition in accordance with ISO 9614 standard. Sound pressure level is not a value declared on Eurovent Program and is converted from sound power level based on a tonality penalty of 0 dB and installation in free-field. The directivity index (Q) is assumed as 2. Therefore, these values can be increased owing to ambient conditions during operation. Rated sound power level is in accordance with EN12102-1 under condition of EN14825.
4. Performances are in accordance with EN14511 and reflect ErP testing conditions. Above gives the declared values at rated conditions according to ErP regulation.
5. This product contains fluorinated greenhouse gases.
6. All installation sites must be equipped with an earth leakage circuit breaker (ELCB).
7. DHW 55 - 80°C Operating is available only when the booster heater is operating.

THERMA V™ R32 SPLIT HYDRO UNIT (5 / 7 / 9 kW)

Performance Table for Heating Operation

Maximum heating capacity (including defrost effect)

HU051MR U44 + HN091MR NK5

Outdoor Temperature	Capacity (kW)							
	LWT 30 °C	LWT 35 °C	LWT 40 °C	LWT 45 °C	LWT 50 °C	LWT 55 °C	LWT 60 °C	LWT 65 °C
-25°C DB	4.02	3.90	3.78	3.66	-	-	-	-
-20°C DB	4.64	4.51	4.38	4.26	4.13	-	-	-
-15°C DB	5.26	5.12	4.99	4.85	4.72	4.58	-	-
-7°C DB	5.50	5.50	5.50	5.50	5.50	5.50	5.50	-
-4°C DB	5.50	5.50	5.50	5.50	5.50	5.50	5.50	-
-2°C DB	5.50	5.50	5.50	5.50	5.50	5.50	5.50	-
2°C DB	5.50	5.50	5.50	5.50	5.50	5.50	5.50	5.50
7°C DB	5.50	5.50	5.50	5.50	5.50	5.50	5.50	5.50
10°C DB	5.50	5.50	5.50	5.50	5.50	5.50	5.50	5.50
15°C DB	5.50	5.50	5.50	5.50	5.50	5.50	5.50	5.50
18°C DB	5.50	5.50	5.50	5.50	5.50	5.50	5.50	5.50
20°C DB	5.50	5.50	5.50	5.50	5.50	5.50	5.50	5.50
35°C DB	5.50	5.50	5.50	5.50	5.50	5.50	5.50	5.50

HU071MR U44 + HN091MR NK5

Outdoor Temperature	Capacity (kW)							
	LWT 30 °C	LWT 35 °C	LWT 40 °C	LWT 45 °C	LWT 50 °C	LWT 55 °C	LWT 60 °C	LWT 65 °C
-25°C DB	5.00	4.85	4.71	4.56	-	-	-	-
-20°C DB	5.58	5.43	5.27	5.11	4.95	-	-	-
-15°C DB	6.17	6.00	5.83	5.66	5.49	5.32	-	-
-7°C DB	7.00	7.00	7.00	7.00	7.00	7.00	7.00	-
-4°C DB	7.00	7.00	7.00	7.00	7.00	7.00	7.00	-
-2°C DB	7.00	7.00	7.00	7.00	7.00	7.00	7.00	-
2°C DB	7.00	7.00	7.00	7.00	7.00	7.00	7.00	7.00
7°C DB	7.00	7.00	7.00	7.00	7.00	7.00	7.00	7.00
10°C DB	7.00	7.00	7.00	7.00	7.00	7.00	7.00	7.00
15°C DB	7.00	7.00	7.00	7.00	7.00	7.00	7.00	7.00
18°C DB	7.00	7.00	7.00	7.00	7.00	7.00	7.00	7.00
20°C DB	7.00	7.00	7.00	7.00	7.00	7.00	7.00	7.00
35°C DB	7.00	7.00	7.00	7.00	7.00	7.00	7.00	7.00

HU091MR U44 + HN091MR NK5

Outdoor Temperature	Capacity (kW)							
	LWT 30 °C	LWT 35 °C	LWT 40 °C	LWT 45 °C	LWT 50 °C	LWT 55 °C	LWT 60 °C	LWT 65 °C
-25°C DB	6.40	6.20	6.00	5.80	-	-	-	-
-20°C DB	7.23	7.00	6.77	6.54	6.31	-	-	-
-15°C DB	8.06	7.80	7.54	7.28	7.02	6.76	-	-
-7°C DB	9.00	9.00	9.00	9.00	9.00	9.00	9.00	-
-4°C DB	9.00	9.00	9.00	9.00	9.00	9.00	9.00	-
-2°C DB	9.00	9.00	9.00	9.00	9.00	9.00	9.00	-
2°C DB	9.00	9.00	9.00	9.00	9.00	9.00	9.00	9.00
7°C DB	9.00	9.00	9.00	9.00	9.00	9.00	9.00	9.00
10°C DB	9.00	9.00	9.00	9.00	9.00	9.00	9.00	9.00
15°C DB	9.00	9.00	9.00	9.00	9.00	9.00	9.00	9.00
18°C DB	9.00	9.00	9.00	9.00	9.00	9.00	9.00	9.00
20°C DB	9.00	9.00	9.00	9.00	9.00	9.00	9.00	9.00
35°C DB	9.00	9.00	9.00	9.00	9.00	9.00	9.00	9.00

Note

- DB : Dry Bulb Temperature (°C), LWT : Leaving Water Temperature (°C), LPM : Liters Per Minute (l/min), TC : Total Capacity (kW)
- Direct interpolation is permissible. Do not extrapolate.
- Measuring procedure follows EN-14511.
 - Rated values are based on standard conditions and it can be found on specifications.
 - Above table values may not be matched according to installation condition. Except for rated value, the performance is not guaranteed.
 - In accordance with the test standard (or nations), the rating will vary slightly.
- The shaded areas are not guaranteed continuous operation.

Performance Table for Cooling Operation

Maximum cooling capacity

HU051MR U44 + HN091MR NK5

Outdoor Temperature	Capacity (kW)						
	LWT 7 °C	LWT 10 °C	LWT 13 °C	LWT 15 °C	LWT 18 °C	LWT 20 °C	LWT 22 °C
10°C DB	6.42	6.95	7.49	7.85	8.39	8.75	9.11
20°C DB	6.05	6.37	6.70	6.91	7.23	7.45	7.66
30°C DB	5.68	5.79	5.90	5.97	6.08	6.15	6.22
35°C DB	5.50	5.50	5.50	5.50	5.50	5.50	5.50
40°C DB	5.32	5.34	5.35	5.37	5.38	5.40	5.41
45°C DB	5.13	5.17	5.21	5.23	5.27	5.29	5.32

HU071MR U44 + HN091MR NK5

Outdoor Temperature	Capacity (kW)						
	LWT 7 °C	LWT 10 °C	LWT 13 °C	LWT 15 °C	LWT 18 °C	LWT 20 °C	LWT 22 °C
10°C DB	8.17	8.85	9.54	9.99	10.68	11.13	11.59
20°C DB	7.70	8.11	8.52	8.80	9.21	9.48	9.75
30°C DB	7.23	7.37	7.51	7.60	7.74	7.83	7.92
35°C DB	7.00	7.00	7.00	7.00	7.00	7.00	7.00
40°C DB	6.77	6.79	6.81	6.83	6.85	6.87	6.88
45°C DB	6.53	6.58	6.63	6.66	6.70	6.74	6.77

HU091MR U44 + HN091MR NK5

Outdoor Temperature	Capacity (kW)						
	LWT 7 °C	LWT 10 °C	LWT 13 °C	LWT 15 °C	LWT 18 °C	LWT 20 °C	LWT 22 °C
10°C DB	10.50	11.38	12.26	12.85	13.73	14.31	14.90
20°C DB	9.90	10.43	10.96	11.31	11.84	12.19	12.54
30°C DB	9.30	9.48	9.65	9.77	9.95	10.06	10.18
35°C DB	9.00	9.00	9.00	9.00	9.00	9.00	9.00
40°C DB	8.70	8.73	8.76	8.78	8.81	8.83	8.85
45°C DB	8.40	8.46	8.52	8.56	8.62	8.66	8.70

Note

- DB : Dry Bulb Temperature (°C), LWT : Leaving Water Temperature (°C), LPM : Liters Per Minute (l/min), TC : Total Capacity (kW)
- Direct interpolation is permissible. Do not extrapolate.
- Measuring procedure follows EN-14511.
 - Rated values are based on standard conditions and it can be found on specifications.
 - Above table values may not be matched according to installation condition. Except for rated value, the performance is not guaranteed.
 - In accordance with the test standard (or nations), the rating will vary slightly.
- The shaded areas are not guaranteed continuous operation.

THERMAV™ R32 SPLIT HYDRO UNIT (5/7/9 kW)

Drawings

HU051MR U44 / HU071MR U44 / HU091MR U44

[Unit: mm]

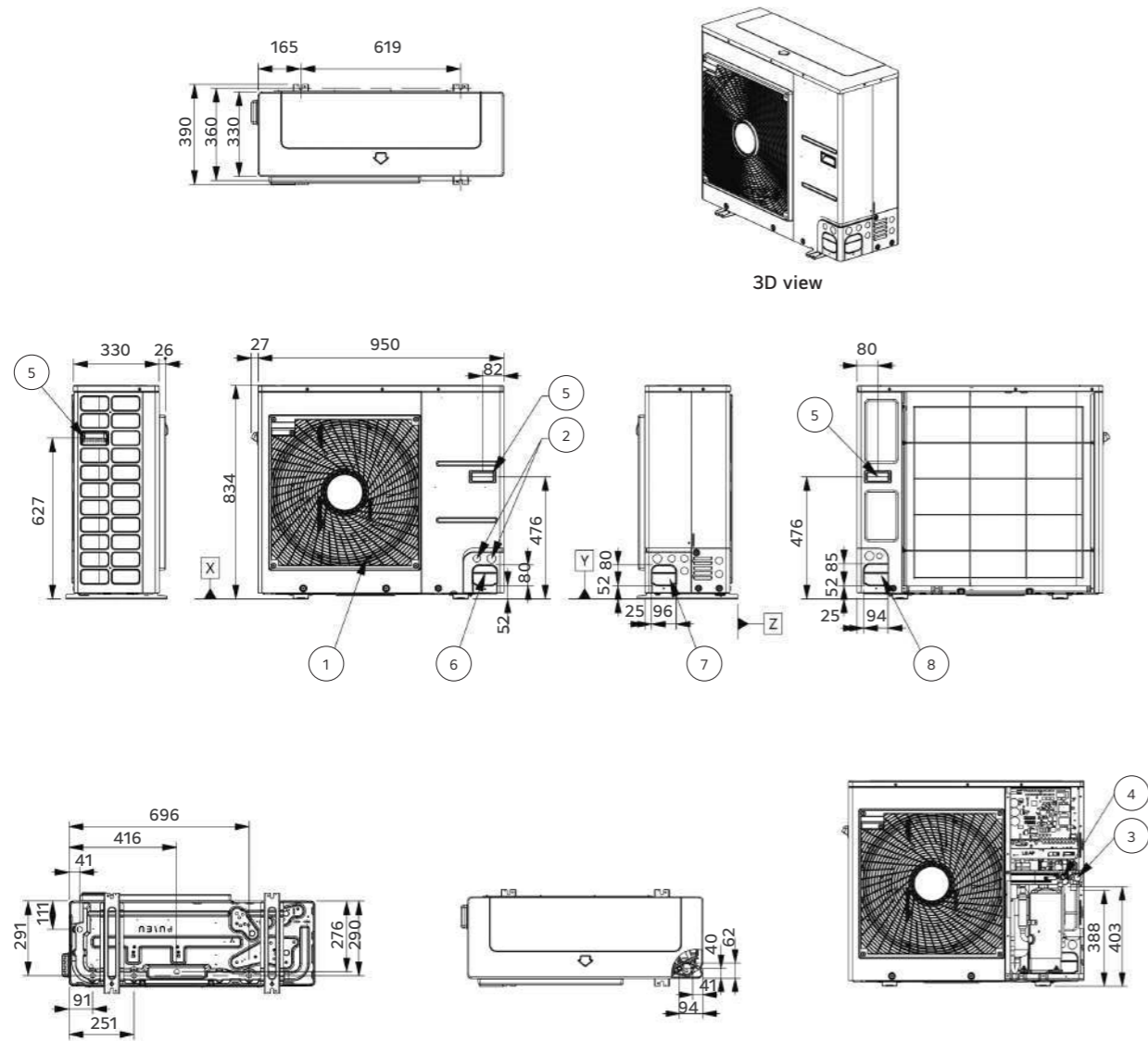

No.	Part name	Description
1	Air outlet	-
2	Power and communication cable hole	-
3	Gas pipe connection	Flare joint
4	Liquid pipe connection	Flare joint
5	Handle	-
6	Pipe routing hole (front)	-
7	Pipe routing hole (side)	-
8	Pipe routing hole (back)	-

HN091MR NK5

[Unit: mm]

External

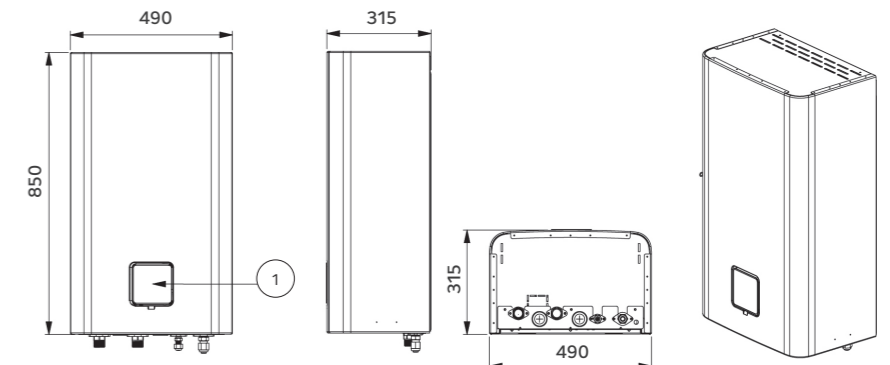

No.	Part name	Description
1	Control panel	Built-in remote controller

Internal

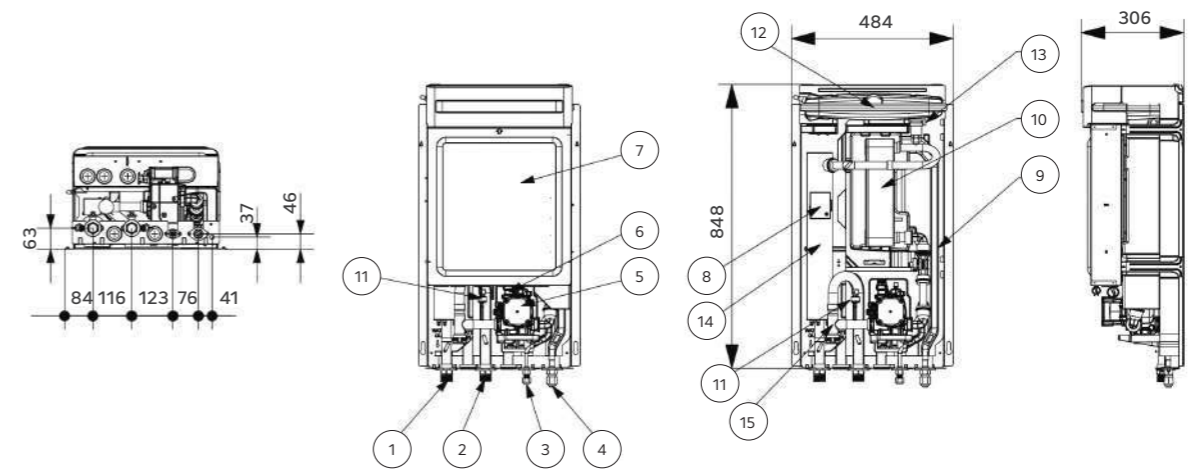

No.	Part name	Description
1	Leaving water pipe	Male PT 1" according to ISO 7-1 (tapered pipe threads)
2	Entering water pipe	Male PT 1" according to ISO 7-1 (tapered pipe threads)
3	Refrigerant pipe (liquid)	Ø 9.52 (mm)
4	Refrigerant pipe (gas)	Ø 15.88 (mm)
5	Water pump	To circulate water inside the system
6	Safety valve	Open at water pressure 3 bar
7	Control box	PCB and terminal blocks
8	Thermal switch	Cut-off power input to electric heater at 90°C
9	Flow sensor	To measure the water flow rate (5-80 LPM)
10	Plate heat exchanger	Heat exchange between refrigerant and water
11	Pressure sensor	To measure the water pressure (0-2 MPa)
12	Expansion tank	Absorbing volume change of heated water
13	Air vent	Air purging when charging water
14	Backup heater	6 kW
15	Strainer	Filtering and stacking particles inside circulating water

THERMA V™

R32 Split Combi Unit



All-in-one integration

What is R32 Split Combi Unit

The LG THERMA V R32 Split Combi Unit is a domestic hot water supply, space heating and cooling solution that conveniently combines an indoor hot water tank with a separate outdoor unit. THERMA V R32 Split Combi Unit is the perfect space-saving solution for residential applications because the Domestic Hot Water (DHW) tank, which are typically installed separately, are fully integrated along with hydronic components. The outdoor unit is on offer in 4/6 kW and 5/7/9 kW capacity range. R32 Split 4/6 kW model is suitable for new build houses that are well insulated and require a small heating load, while R32 Split 5/7/9 kW model is adapted for both new build and renovation projects.

Product Range

Phase	Capacity (kW)	Indoor Unit	Outdoor Unit
1 Ø	4	HN0613T NK0	HU041MR U20
	6		HU061MR U20
	5	HN0913T NK0	HU051MR U44
	7		HU071MR U44
	9		HU091MR U44



Key Features

- Capacity range from 4 and 6 kW for new build and 5 to 9 kW for new build or small renovation
- R32 refrigerant with reduced Global Warming Potential (GWP)
- Maximum flow temperature up to 55°C (4/6 kW) and 65°C (5/7/9 kW)
- Operation range down to -20°C (4/6 kW) and -25°C (5/7/9 kW)
- All-in-one Combi Unit with integrated hot water cylinder

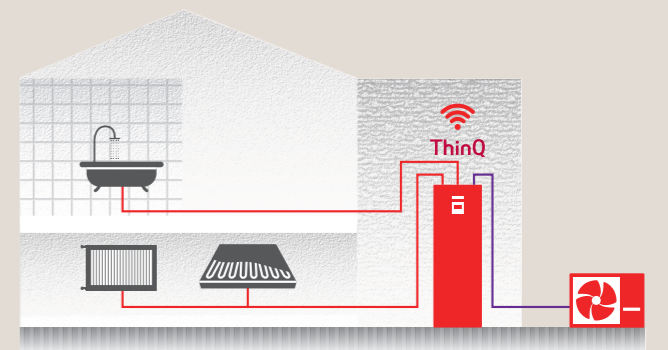

Excellent performance & efficiency

- R32 refrigerant
- R1 Compressor (5/7/9kW only)
- Flash gas injection
- Wide operation range
- Black Fin heat exchanger
- Energy state
- Modbus connectivity

User convenience

- Intuitive interface
- LG ThinQ
- 2nd circuit
- Various control options
- Seasonal auto mode
- 3rd party boiler
- Energy monitoring
- DHW recirculation
- Low noise mode
- Advanced pump control options
- 2 remote control

Easy installation & maintenance

- Water tank integration
- Small refrigerant amount
- Light weight
- Flexible piping design (5/7/9kW only)
- LG BECON cloud
- Clip connection

THERMA V™ R32

HIGHLIGHT OF R32 SPLIT COMBI UNIT



Browse now



All-in-one Integration (Combi Unit)

THERMA V R32 Split Combi Unit is the perfect space-saving solution for residential application thanks to its fully integrated hot water tank. Unlike in the case of typical separate installation, in this all-in-one solution hydronic components and Domestic Hot Water (DHW) are pre-wired, which requires reduced installation time and saves valuable living space. THERMA V R32 Split Combi Unit is easy to set up and operate while it demonstrates outstanding reliability and efficiency.

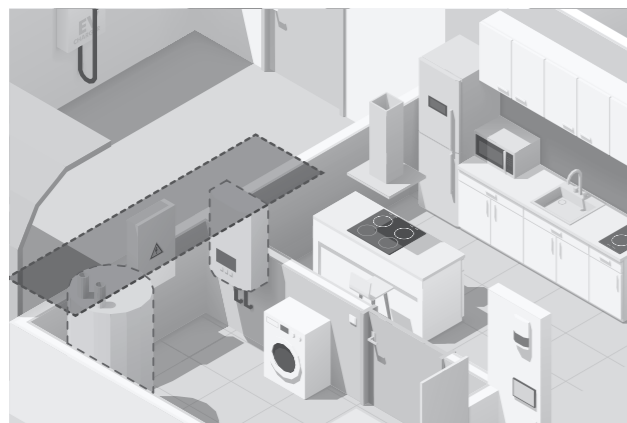

Conventional



LG THERMA V R32 Split Combi Unit
(less installation space required)

Small Refrigerant Amount

- free from minimum floor area requirements due to R32 refrigerant

ONLY 4/6 kW

Minimum floor space requirements do not apply to R32 Split 4/6 kW, as the maximum refrigerant amount (including 30 m pipes) used in the product is smaller than the minimum set by regulation. As a result, there are more opportunities for flexible design and installation.

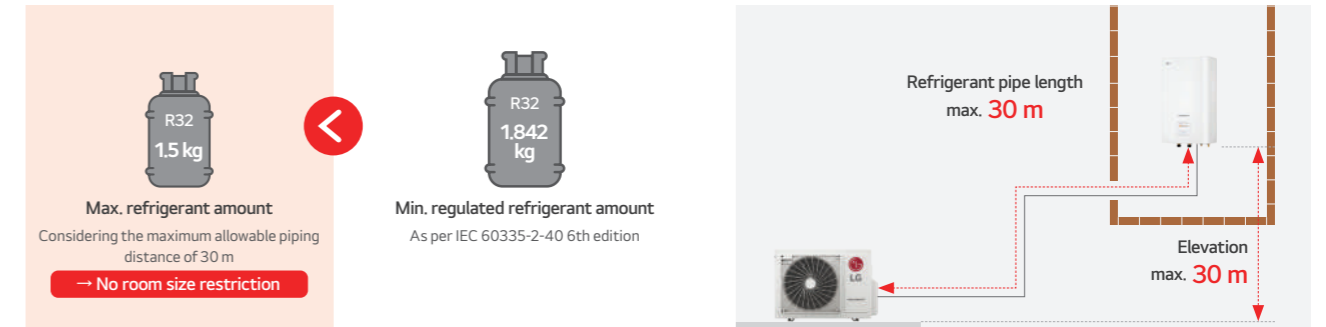

Reduced Noise Level

ONLY 4/6 kW

The R32 Split outdoor unit can be installed at the minimum of 4.5 m away¹⁾ from neighboring houses while complying with noise-related requirements in most European countries, including Germany. (based on 4 kW ODU & low noise mode)

Description		Germany	Austria	Switzerland	Netherlands
Sound pressure threshold	Day time	50 dB (A) (06:00 ~ 22:00)	40 dB (A) (06:00 ~ 19:00)	40 dB (A) (07:00 ~ 19:00)	45 dB (A) (07:00 ~ 19:00)
	Evening	-	35 dB (A) (19:00 ~ 22:00)	-	-
	Night time	35 dB (A) (22:00 ~ 06:00)	30 dB (A) (22:00 ~ 06:00)	35 dB (A) (19:00 ~ 07:00)	40 dB (A) (19:00 ~ 07:00)

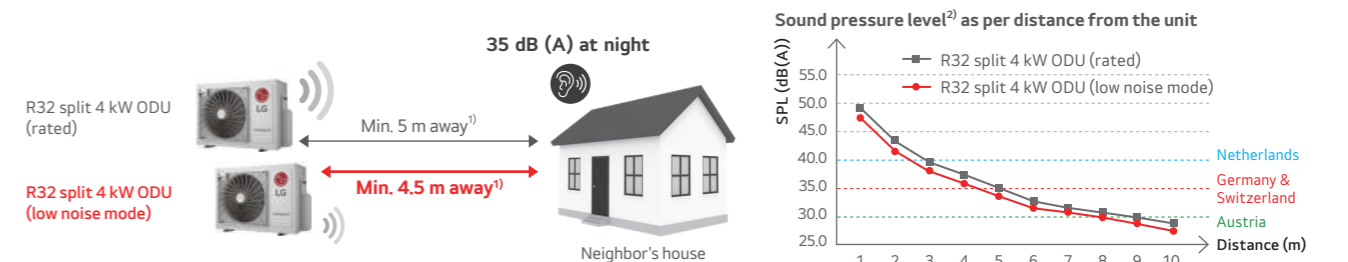

1) Minimum distance to be away from a neighboring property may vary depending on installation conditions and noise regulations in individual countries.
2) Sound pressure level is converted from sound power level of low noise mode based on a tonality penalty of 0 dB and installation in free-field. The directivity index (Q) is assumed as 2.

HIGHLIGHT OF R32 SPLIT COMBI UNIT

Energy States Interlock

THERMA V R32 Split Combi Unit provides an energy state interlock function enabling customers to use their own renewable energy as much as possible. It can shift set points depending on input signal from the Energy Storage System (ESS) or any other third-party device using Modbus or Digital 230 V inputs.

- 1) Energy is generated from solar panels and sent to your battery.
- 2) When the battery is charged, the surplus energy from the ESS will heat the water in your water tank and also the surplus energy can be used to heating your room.
- 3) Surplus energy remaining even after utilized will be automatically converted to be sell to the grid.

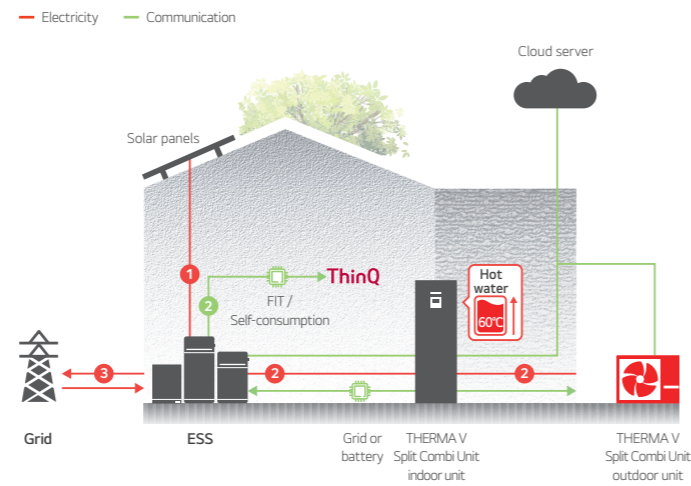

Easy Draining System

It is convenient for maintenance or moving as the water inside can be easily drained through the built-in drain valve.

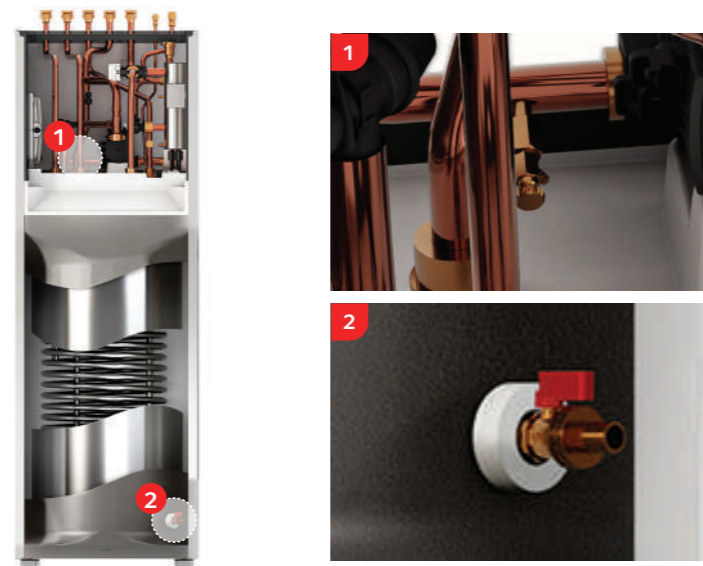

DHW Recirculation Pump Control

THERMA V can be connected to the DHW recirculation pump, which can then be managed via the scheduling function. When a user opens the faucet, hot water is immediately accessible thanks to the DHW recirculating function. This feature also has the added advantage of preventing Legionella growth in the hot water pipe.



THERMA V™ R32

R32 SPLIT COMBI UNIT (4 / 6 kW)

Outdoor unit
HU041MR U20
HU061MR U20

Indoor unit
HN0613T NK0

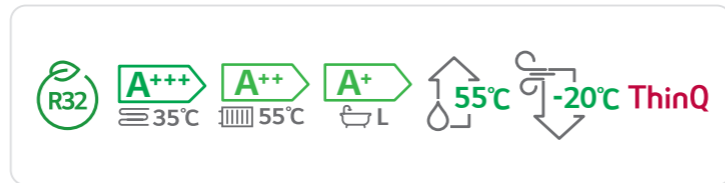
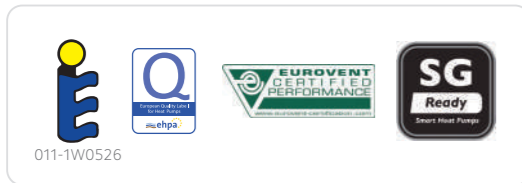

Key Components

Combi Unit

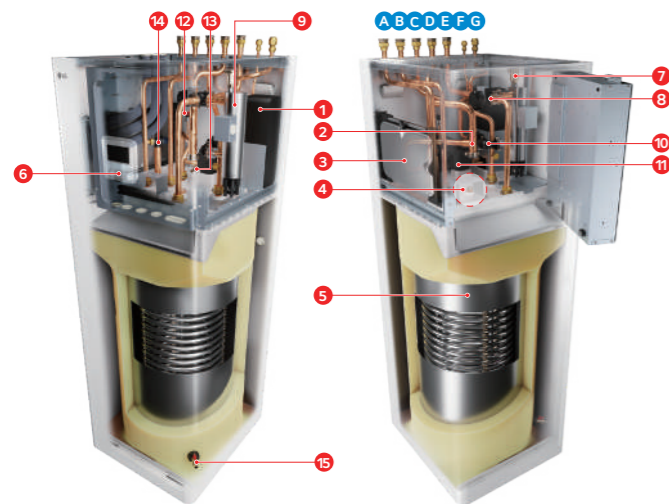

Components

- 1 Plate heat exchanger (ref. / water)
- 2 Strainer
- 3 Expansion tank for heating (8 ℓ)
- 4 Reserved space for DHW expansion tank
- 5 DHW storage tank (stainless steel, 200 ℓ) with internal coil type heat exchanger
- 6 Standard III remote controller¹⁾ (air temp. sensor integrated)
- 7 Air vent valve
- 8 3 Way diverting valve (DC)
- 9 Electric back-up heater (3 kW)
- 10 Water flow sensor
- 11 Main water pump with air vent and safety valve (water circuit, 3 bar)
- 12 Water pressure sensor
- 13 Drain valve for water circuit
- 14 Safety valve (DHW tank, 10 bar)
- 15 Drain valve for DHW tank

1) Temperature control class (ERP class) : V

Connections

- A DHW recirculation pipe (female G1" *)
- B Domestic hot water outlet pipe (female G1" *)
- C Domestic cold water inlet pipe (female G1" *)
- D Heating circuit inlet pipe (female G1" *)
- E Heating circuit outlet pipe (female G1" *)
- F Refrigerant liquid pipe (SAE 1/4" with connector **)
- G Refrigerant gas pipe (SAE 1/2" with connector **)

* According to ISO 228-1 (parallel pipe threads)

** In case of Split 4/6 kW model, the adaptors provided with the outdoor unit must be separately installed on the gas/liquid connection of the indoor unit when connecting the refrigerant pipe. After installing the adaptors, the liquid and gas connection size becomes Ø 6.35 (1/4 inch) and Ø 12.7 (1/2 inch) respectively.

Product Specification

Efficiency Data		Unit	4 kW (1 Ø)	6 kW (1 Ø)
Seasonal space heating eff. class (35°C / 55°C)	-		A+++/A++	A+++/A++
Seasonal space heating efficiency (η_s) (35°C / 55°C)	%		183 / 126	183 / 126
SCOP (35°C / 55°C)	-		4.65 / 3.23	4.65 / 3.23
Declared load profile, average climate	-		L	L
Water heating efficiency (η_{wh}), average climate	%		133	133
COP _{DHW} , average climate	-		3.15	3.15
Water heating eff. class, average climate	-		A+	A+
Annual energy consumption, DHW (average climate)	kWh		770	770
Heating up time acc. to EN 16147 (average climate)	h/mn			1h45
Max. usable water volume acc. to EN 16147 (average climate)	ℓ			220
Declared load profile, warmer climate	-		L	L
Water heating efficiency (η_{wh}), warmer climate	%		160	160
COP _{DHW} , warmer climate	-		3.69	3.69
Water heating eff. class, warmer climate	-		A++	A++
Declared load profile, colder climate	-		L	L
Water heating efficiency (η_{wh}), colder climate	%		110	110
COP _{DHW} , colder climate	-		2.54	2.54
Water heating eff. class, colder climate	-		A	A
Sound power level (outdoor unit)	Rated / low noise mode	dB(A)	57 / 56	58 / 57
Sound pressure level at 5m (outdoor unit)	Rated / low noise mode	dB(A)	35 / 34	36 / 35
Sound power level (indoor unit)	Rated	dB(A)		42
Sound pressure level at 1m (indoor unit)	Rated	dB(A)		34

Nominal Capacity and COP/EER

Air / water	Heating capacity / COP	Unit	4 kW / 5.10	6 kW / 4.95
Air +7°C / water +35°C	Heating capacity / COP	kW / -	4.00 / 5.10	6.00 / 4.95
Air +2°C / water +35°C	Heating capacity / COP	kW / -	3.60 / 3.75	4.80 / 3.65
Air -7°C / water +35°C	Heating capacity / COP	kW / -	4.00 / 3.08	6.00 / 2.98
Air +7°C / water +55°C	Heating capacity / COP	kW / -	3.70 / 2.85	4.60 / 2.90
Air -7°C / water +55°C	Heating capacity / COP	kW / -	3.70 / 1.80	4.60 / 1.80
Air +35°C / water +18°C	Cooling capacity / EER	kW / -	4.00 / 4.80	6.00 / 4.80
Air +35°C / water +7°C	Cooling capacity / EER	kW / -	4.00 / 3.40	6.00 / 3.20

Note

1. Due to our policy of innovation, some specifications may be changed without notification.
2. Wiring cable size must comply with the applicable local and national codes. Especially the power cable and circuit breaker should be selected in accordance with that.
3. Sound power level is measured on the rated condition in accordance with ISO 9614 standard. Sound pressure level is not a value declared on Eurovent Program and is converted from sound power level based on a tonality penalty of 0 dB and installation in free-field. The directivity index (Q) is assumed as 2. Therefore, these values can be increased owing to ambient conditions during operation. Rated sound power level is in accordance with EN12102-1 under condition of EN14825.
4. Performances are in accordance with EN14511 and reflect ErP testing conditions. Above gives the declared values at rated conditions according to ErP regulation.
5. This product contains fluorinated greenhouse gases.
6. All installation sites must be equipped with an earth leakage circuit breaker (ELCB).
7. DHW 50 ~ 80°C Operating is available only when the booster heater is operating.

R32 SPLIT COMBI UNIT (4 / 6 kW)

Product Specification

Outdoor Units		Unit	HU041MR U20	HU061MR U20
Operation range (outdoor air temperature)	Heating & DHW (Min. - Max.)	°C	-20 ~ 35	
	Cooling (Min. - Max.)	°C	5 ~ 48	
Refrigerant	Type	-	R32	
	GWP	-	675	
	Precharged amount	g	1,100	
Piping connections (ref.)	Gas / Liquid	mm (inch)	Ø 12.7 (1/2) / Ø 6.35 (1/4)	
	Length standard / Min. / Max.	m	5 / 30	
	Level difference Max.	m	30	
	Max. length without additional charge	m	10	
	Mass of additional ref. charge	g/m	20	
Dimension	H x W x D	mm	650 x 870 x 330	
Weight	Empty	kg	44.7	
Exterior	Color / RAL code	-	Warm gray / RAL 7044	
Power supply	Voltage, phase, frequency	V, Ø, Hz	220 - 240, 1, 50	
	Standby power consumption	W	20	
	Recommended circuit breaker	A	16	20

Indoor Units		Unit	HN0613T NK0
Operation range (leaving water temperature)	Heating (Min. - Max.)	°C	15 ~ 55
	Cooling (Min. - Max.)	°C	5 ~ 27
	DHW (Min. - Max.)	°C	15 ~ 80
Domestic hot water tank	Volume	ℓ	200
	Tank material	-	Duplex stainless steel
	Standby losses		60
Expansion vessel (heating circuit)	Volume	ℓ	8
Electric heater	Capacity combination	kW	3.0
	Heating steps	Steps	1
	Power supply	V, Ø, Hz	220 - 240, 1, 50
	Rated running current	A	13.0
Piping connections (water)	Inlet / outlet diameter for space heating	inch	Female G1" according to ISO228-1 (parallel pipe threads)
	Inlet / outlet diameter for DHW	inch	
	Recirculation	inch	
Piping connections (ref.)	Gas / Liquid	mm (inch)	Ø 12.7 (1/2) / Ø 6.35 (1/4)
Dimension	H x W x D	mm	1,750 x 600 x 660
Weight	Empty	kg	118.0
Exterior	Color / RAL code	-	White / RAL 9016

Note

1. Due to our policy of innovation, some specifications may be changed without notification.
2. Wiring cable size must comply with the applicable local and national codes. Especially the power cable and circuit breaker should be selected in accordance with that.
3. Sound power level is measured on the rated condition in accordance with ISO 9614 standard. Sound pressure level is converted from sound power level based on a tonality penalty of 0 dB and installation in free-field. The directivity index (Q) is assumed as 2. Therefore, these values can be increased owing to ambient conditions during operation. Rated sound power level is in accordance with EN12102-1 under condition of EN14825.
4. Performances are in accordance with EN14511 and reflect ErP testing conditions. Above gives the declared values at rated conditions according to ErP regulation.
5. This product contains fluorinated greenhouse gases.
6. All installation sites must be equipped with an earth leakage circuit breaker (ELCB).
7. DHW 50 ~ 80°C Operating is available only when the booster heater is operating.



THERMA V™ R32 SPLIT COMBI UNIT (4 / 6 kW)

Performance Table for Heating Operation

Maximum heating capacity (including defrost effect)

HU041MR U20 + HN0613T NKO

Outdoor Temperature	Capacity (kW)					
	LWT 30 °C	LWT 35 °C	LWT 40 °C	LWT 45 °C	LWT 50 °C	LWT 55 °C
-20°C DB	4.00	4.00	4.00	4.00	-	-
-15°C DB	4.00	4.00	4.00	4.00	4.00	-
-7°C DB	4.00	4.00	4.00	4.00	4.00	4.00
-4°C DB	4.00	4.00	4.00	4.00	4.00	4.00
-2°C DB	4.00	4.00	4.00	4.00	4.00	4.00
2°C DB	4.00	4.00	4.00	4.00	4.00	4.00
7°C DB	4.00	4.00	4.00	4.00	4.00	4.00
10°C DB	4.00	4.00	4.00	4.00	4.00	4.00
15°C DB	4.00	4.00	4.00	4.00	4.00	4.00
18°C DB	4.00	4.00	4.00	4.00	4.00	4.00
20°C DB	4.00	4.00	4.00	4.00	4.00	4.00
35°C DB	4.00	4.00	4.00	4.00	4.00	4.00

HU061MR U20 + HN0613T NKO

Outdoor Temperature	Capacity (kW)					
	LWT 30 °C	LWT 35 °C	LWT 40 °C	LWT 45 °C	LWT 50 °C	LWT 55 °C
-20°C DB	4.92	4.78	4.64	4.50	-	-
-15°C DB	5.56	5.52	5.48	5.44	5.40	-
-7°C DB	6.00	6.00	6.00	6.00	6.00	6.00
-4°C DB	6.00	6.00	6.00	6.00	6.00	6.00
-2°C DB	6.00	6.00	6.00	6.00	6.00	6.00
2°C DB	6.00	6.00	6.00	6.00	6.00	6.00
7°C DB	6.00	6.00	6.00	6.00	6.00	6.00
10°C DB	6.00	6.00	6.00	6.00	6.00	6.00
15°C DB	6.00	6.00	6.00	6.00	6.00	6.00
18°C DB	6.00	6.00	6.00	6.00	6.00	6.00
20°C DB	6.00	6.00	6.00	6.00	6.00	6.00
35°C DB	6.00	6.00	6.00	6.00	6.00	6.00

Note

- DB : Dry Bulb Temperature (°C), LWT : Leaving Water Temperature (°C), LPM : Liters Per Minute (l/min), TC : Total Capacity (kW)
- Direct interpolation is permissible. Do not extrapolate.
- Measuring procedure follows EN-14511.
 - Rated values are based on standard conditions and it can be found on specifications.
 - Above table values may not be matched according to installation condition. Except for rated value, the performance is not guaranteed.
 - In accordance with the test standard (or nations), the rating will vary slightly.
- The shaded areas are not guaranteed continuous operation.

Performance Table for Cooling Operation

Maximum cooling capacity

HU041MR U20 + HN0613T NKO

Outdoor Temperature	Capacity (kW)						
	LWT 7 °C	LWT 10 °C	LWT 13 °C	LWT 15 °C	LWT 18 °C	LWT 20 °C	LWT 22 °C
10°C DB	4.00	4.00	4.00	4.00	4.00	4.00	4.00
20°C DB	4.00	4.00	4.00	4.00	4.00	4.00	4.00
30°C DB	4.00	4.00	4.00	4.00	4.00	4.00	4.00
35°C DB	4.00	4.00	4.00	4.00	4.00	4.00	4.00
40°C DB	4.00	4.00	4.00	4.00	4.00	4.00	4.00
45°C DB	4.00	4.00	4.00	4.00	4.00	4.00	4.00

HU061MR U20 + HN0613T NKO

Outdoor Temperature	Capacity (kW)						
	LWT 7 °C	LWT 10 °C	LWT 13 °C	LWT 15 °C	LWT 18 °C	LWT 20 °C	LWT 22 °C
10°C DB	6.00	6.00	6.00	6.00	6.00	6.00	6.00
20°C DB	6.00	6.00	6.00	6.00	6.00	6.00	6.00
30°C DB	6.00	6.00	6.00	6.00	6.00	6.00	6.00
35°C DB	6.00	6.00	6.00	6.00	6.00	6.00	6.00
40°C DB	5.74	5.81	5.87	5.91	6.00	6.00	6.00
45°C DB	5.48	5.61	5.73	5.81	5.94	6.00	6.00

Note

- DB : Dry Bulb Temperature (°C), LWT : Leaving Water Temperature (°C), LPM : Liters Per Minute (l/min), TC : Total Capacity (kW)
- Direct interpolation is permissible. Do not extrapolate.
- Measuring procedure follows EN-14511.
 - Rated values are based on standard conditions and it can be found on specifications.
 - Above table values may not be matched according to installation condition. Except for rated value, the performance is not guaranteed.
 - In accordance with the test standard (or nations), the rating will vary slightly.
- The shaded areas are not guaranteed continuous operation.

THERMAV™ R32 SPLIT COMBI UNIT (4 / 6 kW)

Drawings

HU041MR U20 / HU061MR U20

[Unit: mm]

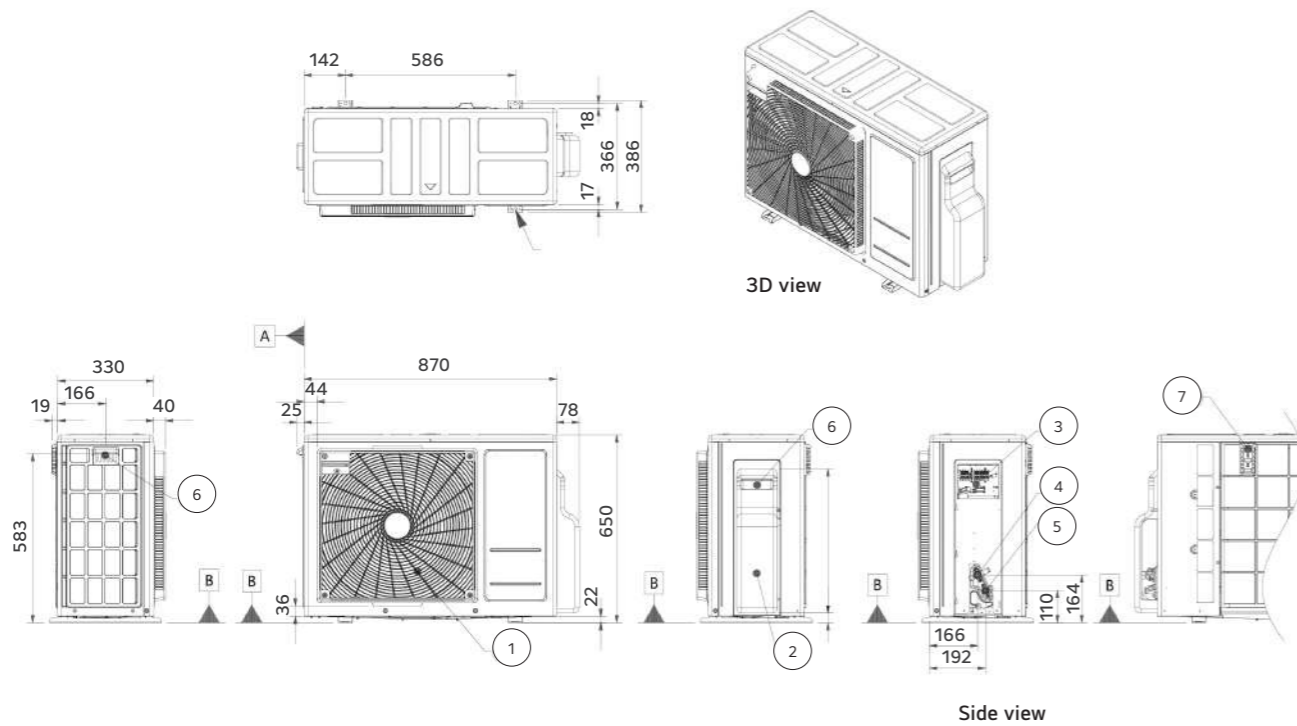

No.	Part name	Description
1	Air outlet	-
2	Control cover & SVC valve cover	-
3	Power and communication cable connection	-
4	Gas pipe connection	Flare joint
5	Liquid pipe connection	Flare joint
6	Handle	-
7	Intake air temperature sensor cover	-

HN0613T NK0

External

[Unit: mm]

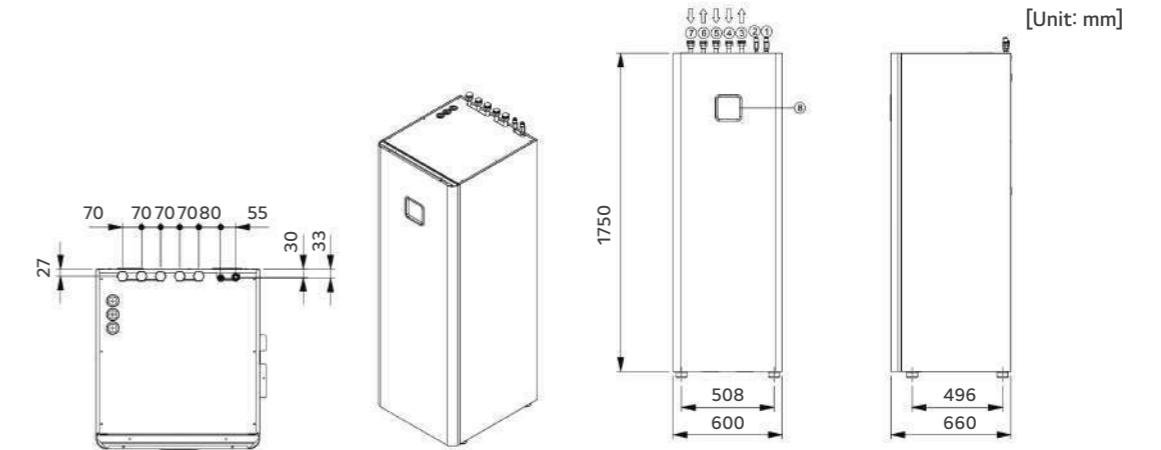

No.	Part name	Description
1	Refrigerant gas pipe	SAE 1/2" ⁽¹⁾
2	Refrigerant liquid pipe	SAE 1/4" ⁽¹⁾
3	Heating circuit outlet pipe	Female G1" according to ISO228-1 (parallel pipe threads)
4	Heating circuit inlet pipe	
5	Domestic cold water inlet pipe	
6	Domestic cold water outlet pipe	
7	DHW re-circulation pipe	
8	Control panel	Built-in remote controller

1) When connecting the refrigerant pipe, the adaptors provided with the outdoor unit must be installed on the connection of the indoor units.

Internal

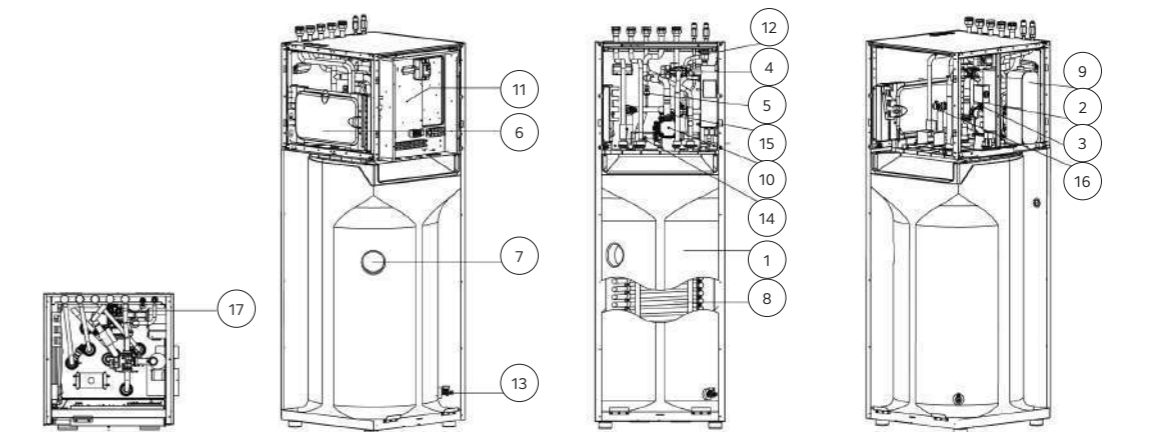

No.	Part name	Description
1	DHW tank	Domestic hot water tank (200 l)
2	Heater	Electric heater (3 kW)
3	Flow sensor	Flow metering sensor
4	3 way valve	For DHW / heating
5	Pressure sensor	Pressure sensor
6	Expansion vessel	8 l for Heating circuit
7	DHW tank sensor	Temperature sensor
8	Heat exchanger 1	Coil heat exchange (water / DHW)
9	Heat exchanger 2	Plate heat exchange (ref. / Water)
10	Water pump	Main circulation pump
11	Control box	PCB'A and terminal blocks
12	Air vent	For air purging
13	Drain cock 1	Valve for DHW tank drain
14	Drain cock 2	Valve for water circuit drain
15	Strainer	For water circuit
16	Safety valve	For DHW (10 bar)
17	Safety valve	For water circuit (3 bar)

THERMA V™ R32

R32 SPLIT COMBI UNIT (5 / 7 / 9 kW)

Outdoor unit
HU051MR U44
HU071MR U44
HU091MR U44

Indoor unit
HN0913T NK0

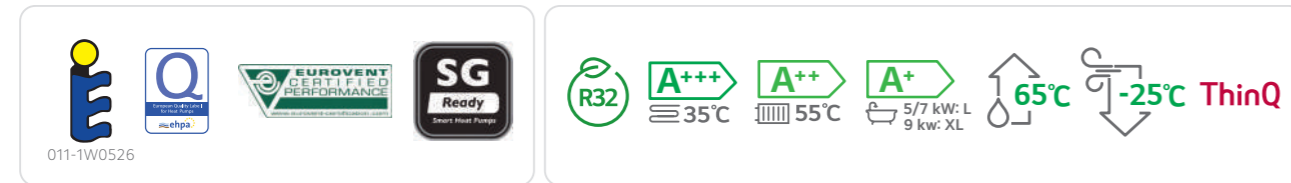

Key Components

Combi Unit

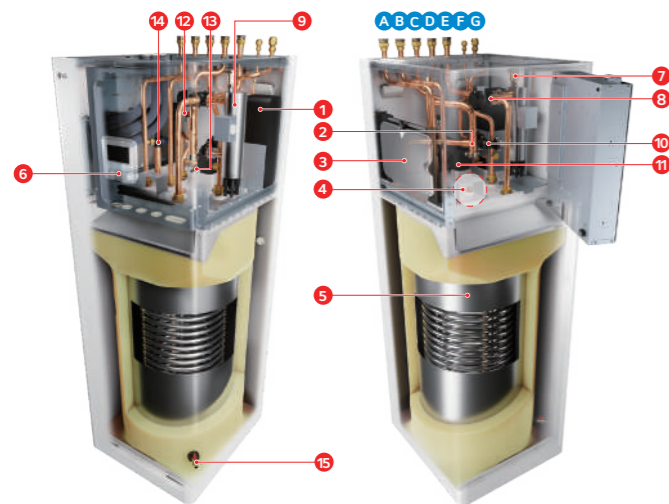

Components

- 1 Plate heat exchanger (ref. / water)
- 2 Strainer
- 3 Expansion tank for heating (8 ℓ)
- 4 Reserved space for DHW expansion tank
- 5 DHW storage tank (stainless steel, 200 ℓ) with internal coil type heat exchanger
- 6 Standard III remote controller¹⁾ (air temp. sensor integrated)
- 7 Air vent valve
- 8 3 Way diverting valve (DC)
- 9 Electric back-up heater (3 kW)
- 10 Water flow sensor
- 11 Main water pump with air vent and safety valve (water circuit, 3 bar)
- 12 Water pressure sensor
- 13 Drain valve for water circuit
- 14 Safety valve (DHW tank, 10 bar)
- 15 Drain valve for DHW tank

1) Temperature control class (ERP class) : V

Connections

- A DHW recirculation pipe (female G1" *)
- B Domestic hot water outlet pipe (female G1" *)
- C Domestic cold water inlet pipe (female G1" *)
- D Heating circuit inlet pipe (female G1" *)
- E Heating circuit outlet pipe (female G1" *)
- F Refrigerant liquid pipe (SAE 3/8")
- G Refrigerant gas pipe (SAE 5/8")

* According to ISO 228-1 (parallel pipe threads)

Product Specification

Efficiency Data	Unit	5 kW (1 Ø)	7 kW (1 Ø)	9 kW (1 Ø)
Seasonal space heating eff. class (35°C / 55°C)	-	A+++ / A++	A+++ / A++	A+++ / A++
Seasonal space heating efficiency (η_s) (35°C / 55°C)	%	183 / 126	183 / 126	183 / 126
SCOP (35°C / 55°C)	-	4.65 / 3.23	4.65 / 3.23	4.65 / 3.23
Declared load profile, average climate	-	L	L	XL
Water heating efficiency (η_{wh}), average climate	%	133	133	140
COP _{DHW} , average climate	-	3.15	3.15	3.40
Water heating eff. class, average climate	-	A+	A+	A+
Annual energy consumption, DHW (average climate)	kWh	770	770	1,196
Heating up time acc. to EN 16147 (average climate)	h/mn		1h44	
Max. usable water volume acc. to EN 16147 (average climate)	ℓ		250	
Declared load profile, warmer climate	-	L	L	XL
Water heating efficiency (η_{wh}), warmer climate	%	160	160	170
COP _{DHW} , warmer climate	-	3.69	3.69	4.10
Water heating eff. class, warmer climate	-	A++	A++	A++
Declared load profile, colder climate	-	L	L	XL
Water heating efficiency (η_{wh}), colder climate	%	110	110	115
COP _{DHW} , colder climate	-	2.54	2.54	2.65
Water heating eff. class, colder climate	-	A	A	A
Sound power level (outdoor unit)	Rated / low noise mode		60 / 58	
Sound pressure level at 5m (outdoor unit)	Rated / low noise mode		38 / 36	
Sound power level (indoor unit)	Rated		42	
Sound pressure level at 1m (indoor unit)	Rated		34	

Nominal Capacity and COP/EER

Air / water	Heating capacity / COP	kW / -	5.50 / 4.90	7.00 / 4.90	9.00 / 4.65
Air +7°C / water +35°C	Heating capacity / COP	kW / -	3.30 / 3.52	4.20 / 3.51	5.40 / 3.50
Air +2°C / water +35°C	Heating capacity / COP	kW / -	5.50 / 2.70	5.50 / 2.70	5.50 / 2.70
Air +7°C / water +55°C	Heating capacity / COP	kW / -	5.50 / 4.60	7.00 / 4.50	9.00 / 4.20
Air +35°C / water +18°C	Cooling capacity / EER	kW / -	5.50 / 2.80	7.00 / 2.70	9.00 / 2.60
Air +35°C / water +7°C	Cooling capacity / EER	kW / -			

Note

1. Due to our policy of innovation, some specifications may be changed without notification.
2. Wiring cable size must comply with the applicable local and national codes. Especially the power cable and circuit breaker should be selected in accordance with that.
3. Sound power level is measured on the rated condition in accordance with ISO 9614 standard. Sound pressure level is converted from sound power level based on a tonality penalty of 0 dB and installation in free-field. The directivity index (Q) is assumed as 2. Therefore, these values can be increased owing to ambient conditions during operation. Rated sound power level is in accordance with EN12102-1 under condition of EN14825.
4. Performances are in accordance with EN14511 and reflect ErP testing conditions. Above gives the declared values at rated conditions according to ErP regulation.
5. This product contains fluorinated greenhouse gases.
6. All installation sites must be equipped with an earth leakage circuit breaker (ELCB).
7. DHW 55 ~ 80°C Operating is available only when the booster heater is operating.

R32 SPLIT COMBI UNIT (5 / 7 / 9 kW)

Product Specification

Outdoor Units		Unit	HU051MR U44	HU071MR U44	HU091MR U44
Operation range (outdoor air temperature)	Heating & DHW (Min. ~ Max.)	°C	-25 ~ 35		
	Cooling (Min. ~ Max.)	°C	5 ~ 48		
Refrigerant	Type	-	R32		
	GWP	-	675		
	Precharged amount	g	1,500		
Piping connections (ref.)	Gas / Liquid	mm (inch)	Ø 15.88 (5/8) / Ø 9.52 (3/8)		
	Length standard / Min. / Max.	m	5 / 50		
	Level difference Max.	m	30		
	Max. length without additional charge	m	10		
	Mass of additional ref. charge	g/m	40		
Dimension	H x W x D	mm	834 x 950 x 330		
Weight	Empty	kg	60.0		
Exterior	Color / RAL code	-	Warm gray / RAL 7044		
Power supply	Voltage, phase, frequency	V, Ø, Hz	220 - 240, 1, 50		
	Standby power consumption	W	20		
	Recommended circuit breaker	A	20	25	30

Indoor Units		Unit	HNO913T NKO
Operation range (leaving water temperature)	Heating (Min. ~ Max.)	°C	15 ~ 65
	Cooling (Min. ~ Max.)	°C	5 ~ 27
	DHW (Min. ~ Max.)	°C	15 ~ 80
Domestic hot water tank	Volume	ℓ	200
	Tank material	-	Duplex stainless steel
	Standby losses		60
Expansion vessel (heating circuit)	Volume	ℓ	8
Electric heater	Capacity combination	kW	3.0
	Heating steps	Steps	1
	Power supply	V, Ø, Hz	220 - 240, 1, 50
	Rated running current	A	13.0
Piping connections (water)	Inlet / outlet diameter for space heating	inch	Female G1" according to ISO228-1 (parallel pipe threads)
	Inlet / outlet diameter for DHW	inch	
	Recirculation	inch	
Piping connections (ref.)	Gas / Liquid	mm (inch)	Ø 15.88 (5/8) / Ø 9.52 (3/8)
Dimension	H x W x D	mm	1,750 x 600 x 660
Weight	Empty	kg	118.0
Exterior	Color / RAL code	-	White / RAL 9016

Note

1. Due to our policy of innovation, some specifications may be changed without notification.
2. Wiring cable size must comply with the applicable local and national codes. Especially the power cable and circuit breaker should be selected in accordance with that.
3. Sound power level is measured on the rated condition in accordance with ISO 9614 standard. Sound pressure level is converted from sound power level based on a tonality penalty of 0 dB and installation in free-field. The directivity index (Q) is assumed as 2. Therefore, these values can be increased owing to ambient conditions during operation. Rated sound power level is in accordance with EN12102-1 under condition of EN14825.
4. Performances are in accordance with EN14511 and reflect ErP testing conditions. Above gives the declared values at rated conditions according to ErP regulation.
5. This product contains fluorinated greenhouse gases.
6. All installation sites must be equipped with an earth leakage circuit breaker (ELCB).
7. DHW 55 ~ 80°C Operating is available only when the booster heater is operating.



THERMA V™ R32 SPLIT COMBI UNIT (5 / 7 / 9 kW)

Performance Table for Heating Operation

Maximum heating capacity (including defrost effect)

HU051MR U44 + HN0913T NKO

Outdoor Temperature	Capacity (kW)							
	LWT 30 °C	LWT 35 °C	LWT 40 °C	LWT 45 °C	LWT 50 °C	LWT 55 °C	LWT 60 °C	LWT 65 °C
-25°C DB	4.02	3.90	3.78	3.66	-	-	-	-
-20°C DB	4.64	4.51	4.38	4.26	4.13	-	-	-
-15°C DB	5.26	5.12	4.99	4.85	4.72	4.58	-	-
-7°C DB	5.50	5.50	5.50	5.50	5.50	5.50	5.50	-
-4°C DB	5.50	5.50	5.50	5.50	5.50	5.50	5.50	-
-2°C DB	5.50	5.50	5.50	5.50	5.50	5.50	5.50	-
2°C DB	5.50	5.50	5.50	5.50	5.50	5.50	5.50	5.50
7°C DB	5.50	5.50	5.50	5.50	5.50	5.50	5.50	5.50
10°C DB	5.50	5.50	5.50	5.50	5.50	5.50	5.50	5.50
15°C DB	5.50	5.50	5.50	5.50	5.50	5.50	5.50	5.50
18°C DB	5.50	5.50	5.50	5.50	5.50	5.50	5.50	5.50
20°C DB	5.50	5.50	5.50	5.50	5.50	5.50	5.50	5.50
35°C DB	5.50	5.50	5.50	5.50	5.50	5.50	5.50	5.50

HU071MR U44 + HN0913T NKO

Outdoor Temperature	Capacity (kW)							
	LWT 30 °C	LWT 35 °C	LWT 40 °C	LWT 45 °C	LWT 50 °C	LWT 55 °C	LWT 60 °C	LWT 65 °C
-25°C DB	5.00	4.85	4.71	4.56	-	-	-	-
-20°C DB	5.58	5.43	5.27	5.11	4.95	-	-	-
-15°C DB	6.17	6.00	5.83	5.66	5.49	5.32	-	-
-7°C DB	7.00	7.00	7.00	7.00	7.00	7.00	6.49	-
-4°C DB	7.00	7.00	7.00	7.00	7.00	7.00	7.00	-
-2°C DB	7.00	7.00	7.00	7.00	7.00	7.00	7.00	-
2°C DB	7.00	7.00	7.00	7.00	7.00	7.00	7.00	7.00
7°C DB	7.00	7.00	7.00	7.00	7.00	7.00	7.00	7.00
10°C DB	7.00	7.00	7.00	7.00	7.00	7.00	7.00	7.00
15°C DB	7.00	7.00	7.00	7.00	7.00	7.00	7.00	7.00
18°C DB	7.00	7.00	7.00	7.00	7.00	7.00	7.00	7.00
20°C DB	7.00	7.00	7.00	7.00	7.00	7.00	7.00	7.00
35°C DB	7.00	7.00	7.00	7.00	7.00	7.00	7.00	7.00

HU091MR U44 + HN0913T NKO

Outdoor Temperature	Capacity (kW)							
	LWT 30 °C	LWT 35 °C	LWT 40 °C	LWT 45 °C	LWT 50 °C	LWT 55 °C	LWT 60 °C	LWT 65 °C
-25°C DB	6.40	6.20	6.00	5.80	-	-	-	-
-20°C DB	7.23	7.00	6.77	6.54	6.31	-	-	-
-15°C DB	8.06	7.80	7.54	7.28	7.02	7.10	-	-
-7°C DB	9.00	9.00	9.00	9.00	9.00	9.00	8.60	-
-4°C DB	9.00	9.00	9.00	9.00	9.00	9.00	9.00	-
-2°C DB	9.00	9.00	9.00	9.00	9.00	9.00	9.00	-
2°C DB	9.00	9.00	9.00	9.00	9.00	9.00	9.00	9.00
7°C DB	9.00	9.00	9.00	9.00	9.00	9.00	9.00	9.00
10°C DB	9.00	9.00	9.00	9.00	9.00	9.00	9.00	9.00
15°C DB	9.00	9.00	9.00	9.00	9.00	9.00	9.00	9.00
18°C DB	9.00	9.00	9.00	9.00	9.00	9.00	9.00	9.00
20°C DB	9.00	9.00	9.00	9.00	9.00	9.00	9.00	9.00
35°C DB	9.00	9.00	9.00	9.00	9.00	9.00	9.00	7.95

Note

- DB : Dry Bulb Temperature (°C), LWT : Leaving Water Temperature (°C), LPM : Liters Per Minute (l/min), TC : Total Capacity (kW)
- Direct interpolation is permissible. Do not extrapolate.
- Measuring procedure follows EN-14511.
 - Rated values are based on standard conditions and it can be found on specifications.
 - Above table values may not be matched according to installation condition. Except for rated value, the performance is not guaranteed.
 - In accordance with the test standard (or nations), the rating will vary slightly.
- The shaded areas are not guaranteed continuous operation.

Performance Table for Cooling Operation

Maximum cooling capacity

HU051MR U44 + HN0913T NKO

Outdoor Temperature	Capacity (kW)						
	LWT 7 °C	LWT 10 °C	LWT 13 °C	LWT 15 °C	LWT 18 °C	LWT 20 °C	LWT 22 °C
10°C DB	5.50	5.50	5.50	5.50	5.50	5.50	5.50
20°C DB	5.50	5.50	5.50	5.50	5.50	5.50	5.50
30°C DB	5.50	5.50	5.50	5.50	5.50	5.50	5.50
35°C DB	5.50	5.50	5.50	5.50	5.50	5.50	5.50
40°C DB	5.32	5.34	5.35	5.37	5.38	5.40	5.41
45°C DB	5.13	5.17	5.21	5.23	5.27	5.29	5.32

HU071MR U44 + HN0913T NKO

Outdoor Temperature	Capacity (kW)						
	LWT 7 °C	LWT 10 °C	LWT 13 °C	LWT 15 °C	LWT 18 °C	LWT 20 °C	LWT 22 °C
10°C DB	7.00	7.00	7.00	7.00	7.00	7.00	7.00
20°C DB	7.00	7.00	7.00	7.00	7.00	7.00	7.00
30°C DB	7.00	7.00	7.00	7.00	7.00	7.00	7.00
35°C DB	7.00	7.00	7.00	7.00	7.00	7.00	7.00
40°C DB	6.50	6.63	6.81	7.00	7.00	7.00	7.00
45°C DB	6.43	6.48	6.63	6.66	6.70	6.74	6.77

HU091MR U44 + HN0913T NKO

Outdoor Temperature	Capacity (kW)						
	LWT 7 °C	LWT 10 °C	LWT 13 °C	LWT 15 °C	LWT 18 °C	LWT 20 °C	LWT 22 °C
10°C DB	9.00	9.00	9.00	9.00	9.00	9.00	9.00
20°C DB	9.00	9.00	9.00	9.00	9.00	9.00	9.00
30°C DB	9.00	9.00	9.00	9.00	9.00	9.00	9.00
35°C DB	9.00	9.00	9.00	9.00	9.00	9.00	9.00
40°C DB	8.10	8.10	8.70	9.00	9.00	9.00	9.00
45°C DB	7.50	7.70	7.80	7.90	8.00	8.10	8.20

Note

- DB : Dry Bulb Temperature (°C), LWT : Leaving Water Temperature (°C), LPM : Liters Per Minute (l/min), TC : Total Capacity (kW)
- Direct interpolation is permissible. Do not extrapolate.
- Measuring procedure follows EN-14511.
 - Rated values are based on standard conditions and it can be found on specifications.
 - Above table values may not be matched according to installation condition. Except for rated value, the performance is not guaranteed.
 - In accordance with the test standard (or nations), the rating will vary slightly.
- The shaded areas are not guaranteed continuous operation.

THERMAV™ R32 SPLIT COMBI UNIT (5 / 7 / 9 kW)

Drawings

HU051MR U44 / HU071MR U44 / HU091MR U44

[Unit: mm]

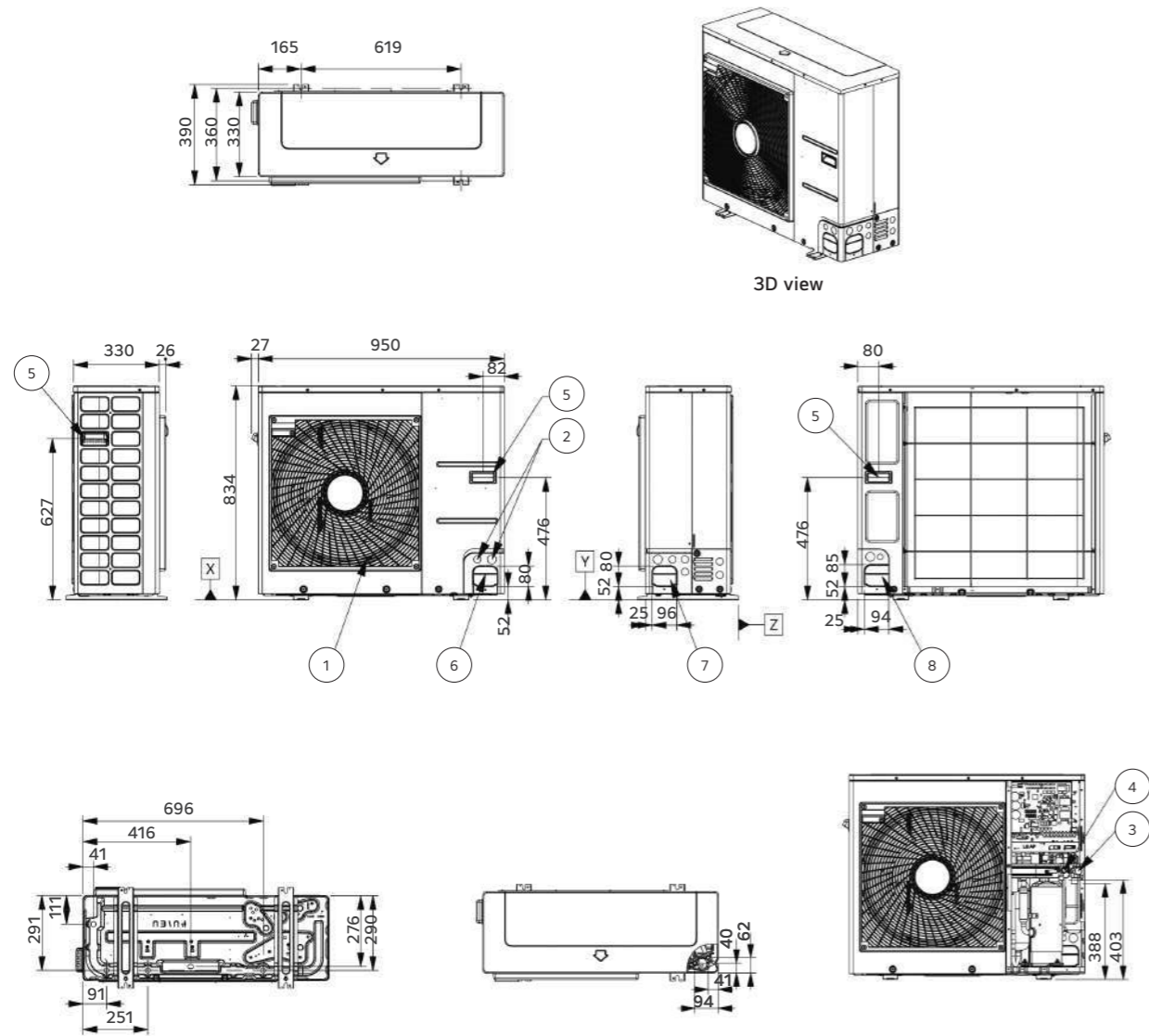

No.	Part name	Description
1	Air outlet	-
2	Power and communication cable hole	-
3	Gas pipe connection	Flare joint
4	Liquid pipe connection	Flare joint
5	Handle	-
6	Pipe routing hole (front)	-
7	Pipe routing hole (side)	-
8	Pipe routing hole (back)	-

HN0913T NK0

[Unit: mm]

External

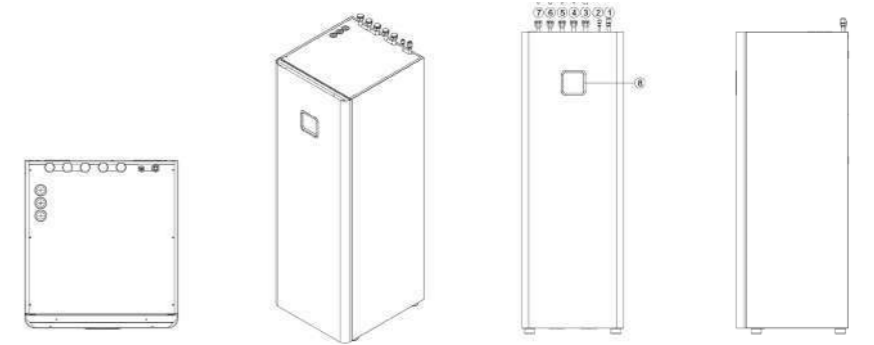

No.	Part name	Description
1	Refrigerant gas pipe	SAE 5/8"
2	Refrigerant liquid pipe	SAE 3/8"
3	Heating circuit outlet pipe	Female G1" according to ISO228-1 (parallel pipe threads)
4	Heating circuit inlet pipe	
5	Domestic cold water inlet pipe	
6	Domestic cold water outlet pipe	
7	DHW re-circulation pipe	
8	Control panel	Built-in remote controller

Internal

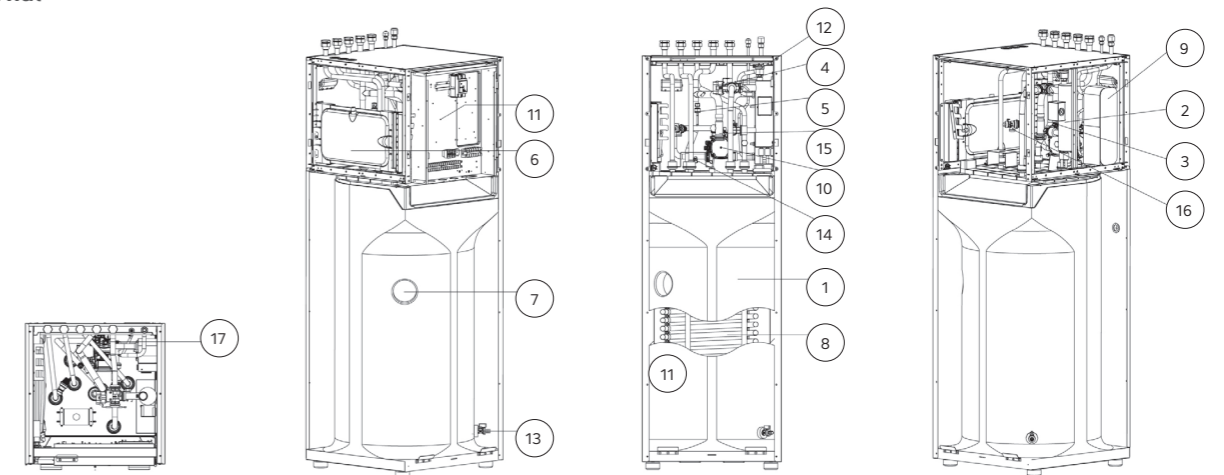

No.	Part name	Description
1	DHW tank	Domestic hot water tank (200 l)
2	Heater	Electric heater (3 kW)
3	Flow sensor	Flow metering sensor
4	3 way valve	For DHW / heating
5	Pressure sensor	Pressure sensor
6	Expansion vessel	8 l for heating circuit
7	DHW tank sensor	Temperature sensor
8	Heat exchanger 1	Coil heat exchange (water / DHW)
9	Heat exchanger 2	Plate heat exchange (ref. / water)

No.	Part name	Description
10	Water pump	Main circulation pump
11	Control box	PCB/A and terminal blocks
12	Air vent	For air purging
13	Drain cock 1	Valve for DHW tank drain
14	Drain cock 2	Valve for water circuit drain
15	Strainer	For water circuit
16	Safety valve	For DHW (10 bar)
17	Safety valve	For water circuit (3 bar)

THERMA V™

R410A Split Hydro Unit



Effortless Installation, Cold-Weather Resilience

What is R410A Split Hydro Unit

The LG THERMA V Split series is a heat pump that is easy, flexible to install. As the expression "split" suggests, the outdoor and indoor units are connected by refrigerant piping, thus freezing will not compromise this unit regardless of outdoor ambient temperatures. LG's THERMA V R410A Split Hydro Unit is designed for the benefit of users and installers who want to apply a heating solution to a large capacity building or applications subject to colder climate conditions. It has a maximized energy efficiency of A++ in the mid-temperature ranges, which results in reduced operating costs.

Product Range

Phase	Capacity (kW)	Indoor Unit	Outdoor Unit
1 Ø	12	HN1616M NK5	HU121MA U33
	14		HU141MA U33
	16		HU161MA U33
3 Ø	12	HN1636M NK5	HU123MA U33
	14		HU143MA U33
	16		HU163MA U33



Key Features

- Capacity range from 12 to 16 kW for renovation
- Operation range down to -25°C
- Maximum flow temperature up to 57°C
- High level hydronic components integration for fast and clean installation

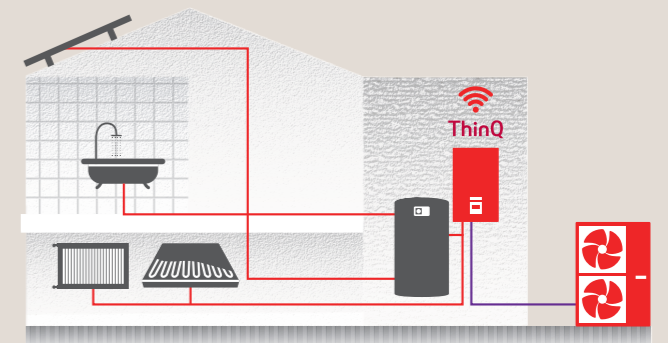

Excellent performance & efficiency

- R410A refrigerant
- R1 Compressor
- Wide operation range
- Gold Fin heat exchanger
- Solar thermal
- Energy state
- Modbus connectivity

User convenience

- Intuitive interface
- LG ThinQ
- 2nd circuit
- Various control options
- Seasonal auto mode
- 3rd party boiler
- Energy monitoring
- DHW recirculation
- Low noise mode
- Advanced pump control options
- 2 remote control

Easy installation & maintenance

- Flexible piping design
- LG BECON cloud
- Clip connection

THERMA V™ R410A
HIGHLIGHT OF R410A SPLIT HYDRO UNIT



[Browse now](#)



Flexible Refrigerant Piping Design

Installation flexibility is enabled by THERMA V Split's long pipe length (up to 50 m) and the fact that the refrigerant piping can be connected in three directions: front, side and rear.

Piping capabilities

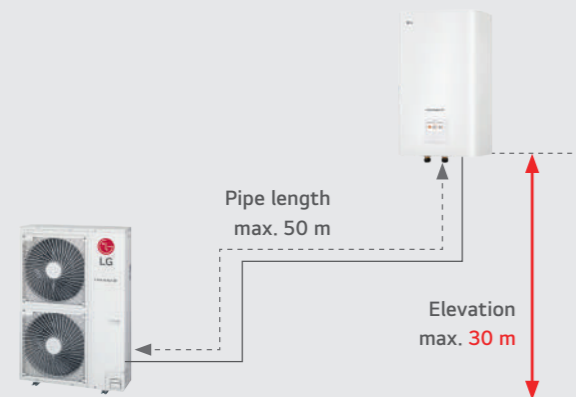

3 way piping

• Neat & easy installation enabled by the three-way piping.

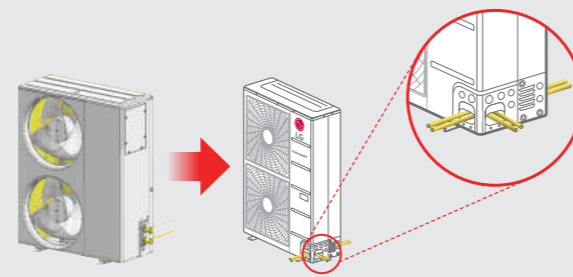

THERMA V™ R410A SPLIT HYDRO UNIT

Outdoor unit

HU121MA U33 / HU123MA U33
HU141MA U33 / HU143MA U33
HU161MA U33 / HU163MA U33

Indoor unit

HN1616M NK5
HN1636M NK5

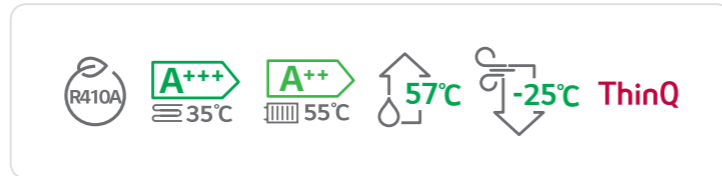

Key Components

Hydro Unit

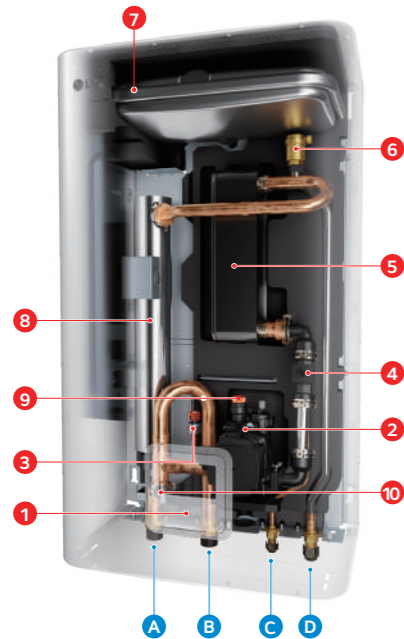

Components

- 1 Standard III remote controller¹⁾ (air temp. sensor integrated)
- 2 Water pump
- 3 Water pressure sensor
- 4 Flow sensor
- 5 Plate type heat exchanger (ref/water)
- 6 Air vent valve
- 7 Expansion vessel (8 ℓ)
- 8 Back up electric heater (3 kW)
- 9 Safety valve
- 10 Strainer

1) Temperature control class (ERP class) : V

Connections

- A Heating circuit outlet pipe (male PT 1" *)
- B Heating circuit inlet pipe (male PT 1" *)
- C Refrigerant liquid pipe (SAE 3/8")
- D Refrigerant gas pipe (SAE 5/8")

* According to ISO 7-1 (tapered pipe threads)

Product Specification

Efficiency Data		Unit	12 kW (1 Ø) 12 kW (3 Ø)	14 kW (1 Ø) 14 kW (3 Ø)	16 kW (1 Ø) 16 kW (3 Ø)
Seasonal space heating eff. class (35°C / 55°C)	-		A+++/A++	A+++/A++	A+++/A++
Seasonal space heating efficiency (η _S) (35°C / 55°C)	%		183 / 131	182 / 132	179 / 130
SCOP (35°C / 55°C)	-		4.65 / 3.36	4.61 / 3.37	4.56 / 3.32
Sound power level (outdoor unit)	Rated / low noise mode	dB(A)	63 / 61	64 / 62	65 / 63
Sound pressure level at 5m (outdoor unit)	Rated / low noise mode	dB(A)	41 / 39	42 / 40	43 / 41
Sound power level (indoor unit)	Rated	dB(A)	44		
Sound pressure level at 1m (indoor unit)	Rated	dB(A)	36		

Nominal Capacity and COP/EER

Air / water temperature	Heating capacity / COP	kW / -	12 kW / 4.55	14 kW / 4.41	16 kW / 4.26
Air +7°C / water +35°C	Heating capacity / COP	kW / -	11.00 / 3.62	12.00 / 3.61	13.80 / 3.60
Air +7°C / water +55°C	Heating capacity / COP	kW / -	11.00 / 2.55	11.50 / 2.55	12.00 / 2.55
Air +35°C / water +18°C	Cooling capacity / EER	kW / -	10.40 / 4.00	12.00 / 3.90	13.00 / 3.61
Air +35°C / water +7°C	Cooling capacity / EER	kW / -	7.94 / 2.98	8.50 / 2.81	8.92 / 3.53

Outdoor Units		Unit	HU121MA U33 HU123MA U33	HU141MA U33 HU143MA U33	HU161MA U33 HU163MA U33
Operation range (outdoor air temperature)	Heating & DHW (Min. ~ Max.)	°C	-25 ~ 35		
	Cooling (Min. ~ Max.)	°C	5 ~ 48		
Refrigerant	Type	-	R410A		
	GWP	-	2,088		
	Precharged amount	g	2,500		
Piping connections (ref.)	Gas / Liquid	mm (inch)	Ø 15.88 (5/8) / Ø 9.52 (3/8)		
	Length standard / Max.	m	7.5 / 50		
	Level difference Max.	m	30		
	Max. length without additional charge	m	7.5		
	Mass of additional ref. charge	g/m	40		
Dimension	H x W x D	mm	1,380 x 950 x 330		
Weight	Empty	kg	84.8 / 85.4		
Exterior	Color / RAL code	-	Warm gray / RAL 7044		
	Voltage, phase, frequency	V, Ø, Hz	220-240, 1, 50 / 380-415, 3, 50		
Power supply	Standby power consumption	W	60		
	Recommended circuit breaker (1 Ø / 3 Ø)	A	40 / 20		

Indoor Units		Unit	HN1616M NK5 HN1636M NK5
Operation range (leaving water temperature)	Heating (Min. ~ Max.)	°C	15 ~ 57
	Cooling (Min. ~ Max.)	°C	5 ~ 27
	DHW (Min. ~ Max.)	°C	15 ~ 80
Expansion vessel (heating circuit)	Volume	ℓ	8
	Capacity combination	kW	3.0 + 3.0 / 2.0 + 2.0 + 2.0
Backup heater	Heating steps	Steps	2
	Power supply	V, Ø, Hz	220-240, 1, 50 / 380-415, 3, 50
	Rated running current	A	25.0 / 8.7
Piping connections (water)	Inlet / outlet diameter	inch	Male PT 1" according to ISO 7-1 (tapered pipe threads)
Piping connections (ref.)	Gas / Liquid	mm (inch)	Ø 15.88 (5/8) / Ø 9.52 (3/8)
Dimension	H x W x D	mm	850 x 490 x 315
Weight	Empty	kg	40.5 / 41.5
Exterior	Color / RAL code	-	Noble white / RAL 9016

Note

1. Due to our policy of innovation, some specifications may be changed without notification.
2. Wiring cable size must comply with the applicable local and national codes. Especially the power cable and circuit breaker should be selected in accordance with that.
3. Sound power level is measured on the rated condition in accordance with ISO 9614 standard. Sound pressure level is not a value declared on Eurovent Program and is converted from sound power level based on a tonality penalty of 0 dB and installation in free-field. The directivity index (Q) is assumed as 2. Therefore, these values can be increased owing to ambient conditions during operation. Rated sound power level is in accordance with EN12102-1 under condition of EN14825.
4. Performances are in accordance with EN14511 and reflect ErP testing conditions. Above gives the declared values at rated conditions according to ErP regulation.
5. This product contains fluorinated greenhouse gases.
6. All installation sites must be equipped with an earth leakage circuit breaker (ELCB).
7. DHW 50 ~ 80°C Operating is available only when the booster heater is operating.

THERMA V™ R410A SPLIT HYDRO UNIT

Performance Table for Heating Operation

Maximum heating capacity (including defrost effect)

HU121MA U33 + HN1616M NK5 / HU123MA U33 + HN1636M NK5

Outdoor Temperature	Capacity (kW)					
	LWT 30 °C	LWT 35 °C	LWT 40 °C	LWT 45 °C	LWT 50 °C	LWT 55 °C
-20°C DB	11.25	10.95	10.22	9.85	-	-
-15°C DB	12.00	11.32	10.90	10.32	-	-
-7°C DB	12.00	11.66	11.45	11.16	11.13	-
-4°C DB	12.00	12.00	12.00	12.00	12.00	11.24
-2°C DB	12.00	12.00	12.00	12.00	12.00	11.98
2°C DB	12.00	12.00	12.00	12.00	12.00	12.00
7°C DB	12.00	12.00	12.00	12.00	12.00	12.00
10°C DB	12.00	12.00	12.00	12.00	12.00	12.00
15°C DB	12.00	12.00	12.00	12.00	12.00	12.00
18°C DB	12.00	12.00	12.00	12.00	12.00	12.00
20°C DB	12.00	12.00	12.00	12.00	12.00	12.00
35°C DB	12.00	12.00	12.00	12.00	12.00	12.00

HU141MA U33 + HN1616M NK5 / HU143MA U33 + HN1636M NK5

Outdoor Temperature	Capacity (kW)					
	LWT 30 °C	LWT 35 °C	LWT 40 °C	LWT 45 °C	LWT 50 °C	LWT 55 °C
-20°C DB	11.25	11.17	10.79	10.32	-	-
-15°C DB	12.11	11.98	11.54	10.90	-	-
-7°C DB	13.06	12.99	12.77	12.27	12.42	-
-4°C DB	14.00	14.00	14.00	13.64	13.09	11.67
-2°C DB	14.00	14.00	14.00	14.00	14.00	12.67
2°C DB	14.00	14.00	14.00	14.00	14.00	13.98
7°C DB	14.00	14.00	14.00	14.00	14.00	14.00
10°C DB	14.00	14.00	14.00	14.00	14.00	14.00
15°C DB	14.00	14.00	14.00	14.00	14.00	14.00
18°C DB	14.00	14.00	14.00	14.00	14.00	14.00
20°C DB	14.00	14.00	14.00	14.00	14.00	14.00
35°C DB	14.00	14.00	14.00	14.00	14.00	14.00

HU161MA U33 + HN1616M NK5 / HU163MA U33 + HN1636M NK5

Outdoor Temperature	Capacity (kW)					
	LWT 30 °C	LWT 35 °C	LWT 40 °C	LWT 45 °C	LWT 50 °C	LWT 55 °C
-20°C DB	12.27	12.01	11.48	10.86	-	-
-15°C DB	13.11	12.90	12.62	12.30	-	-
-7°C DB	13.73	13.70	13.46	13.16	12.42	-
-4°C DB	14.36	14.50	14.30	14.01	13.40	12.50
-2°C DB	15.20	14.80	14.50	14.25	14.00	13.50
2°C DB	16.00	16.00	16.00	16.00	16.00	14.51
7°C DB	16.00	16.00	16.00	16.00	16.00	16.00
10°C DB	16.00	16.00	16.00	16.00	16.00	16.00
15°C DB	16.00	16.00	16.00	16.00	16.00	16.00
18°C DB	16.00	16.00	16.00	16.00	16.00	16.00
20°C DB	16.00	16.00	16.00	16.00	16.00	16.00
35°C DB	16.00	16.00	16.00	16.00	16.00	16.00

Note

- DB: Dry Bulb Temperature (°C), LWT: Leaving Water Temperature (°C)
- Direct interpolation is permissible. Do not extrapolate.
- Measuring procedure follows EN-14511.
 - Rated values are based on standard conditions and can be found on specifications.
 - Above table values may not be matched according to installation conditions. Except for rated values, the performance is not guaranteed.
 - The rating might slightly vary depending on test standards or countries.
- The shaded areas are not guaranteed continuous operation.

Performance Table for Cooling Operation

Maximum cooling capacity

HU121MA U33 + HN1616M NK5 / HU123MA U33 + HN1636M NK5

Outdoor Temperature	Capacity (kW)					
	LWT 7 °C	LWT 10 °C	LWT 13 °C	LWT 15 °C	LWT 18 °C	LWT 20 °C
20°C DB	7.60	8.55	9.51	10.33	11.19	11.98
30°C DB	8.62	9.05	9.78	10.67	10.90	11.37
35°C DB	7.94	8.66	9.33	10.10	10.40	10.75
40°C DB	7.56	8.02	8.81	9.36	9.54	9.89
45°C DB	6.38	7.08	7.79	8.44	9.14	9.44

HU141MA U33 + HN1616M NK5 / HU143MA U33 + HN1636M NK5

Outdoor Temperature	Capacity (kW)					
	LWT 7 °C	LWT 10 °C	LWT 13 °C	LWT 15 °C	LWT 18 °C	LWT 20 °C
20°C DB	8.13	9.87	10.97	11.92	12.91	13.82
30°C DB	9.24	10.44	11.29	12.31	12.58	13.12
35°C DB	8.50	9.99	10.76	11.65	12.00	12.40
40°C DB	8.10	9.25	10.17	10.80	11.01	11.42
45°C DB	7.17	8.17	8.99	9.73	10.55	10.89

HU161MA U33 + HN1616M NK5 / HU163MA U33 + HN1636M NK5

Outdoor Temperature	Capacity (kW)					
	LWT 7 °C	LWT 10 °C	LWT 13 °C	LWT 15 °C	LWT 18 °C	LWT 20 °C
20°C DB	8.54	10.69	11.89	12.91	13.98	14.97
30°C DB	9.70	11.31	12.22	13.34	13.63	14.21
35°C DB	8.92	10.82	11.66	12.63	13.00	13.43
40°C DB	8.51	10.03	11.02	11.70	11.93	12.37
45°C DB	7.52	8.85	9.73	10.55	11.42	11.8

Note

- DB: Dry Bulb Temperature (°C), LWT: Leaving Water Temperature (°C)
- Direct interpolation is permissible. Do not extrapolate.
- Measuring procedure follows EN-14511.
 - Rated values are based on standard conditions and can be found on specifications.
 - Above table values may not be matched according to installation conditions. Except for rated values, the performance is not guaranteed.
 - The rating might slightly vary depending on test standards or countries.
- The shaded areas are not guaranteed continuous operation.

THERMA V™ R410A SPLIT HYDRO UNIT

Drawings

HU121MA U33 / HU141MA U33 / HU161MA U33 /
HU123MA U33 / HU143MA U33 / HU163MA U33

[Unit: mm]

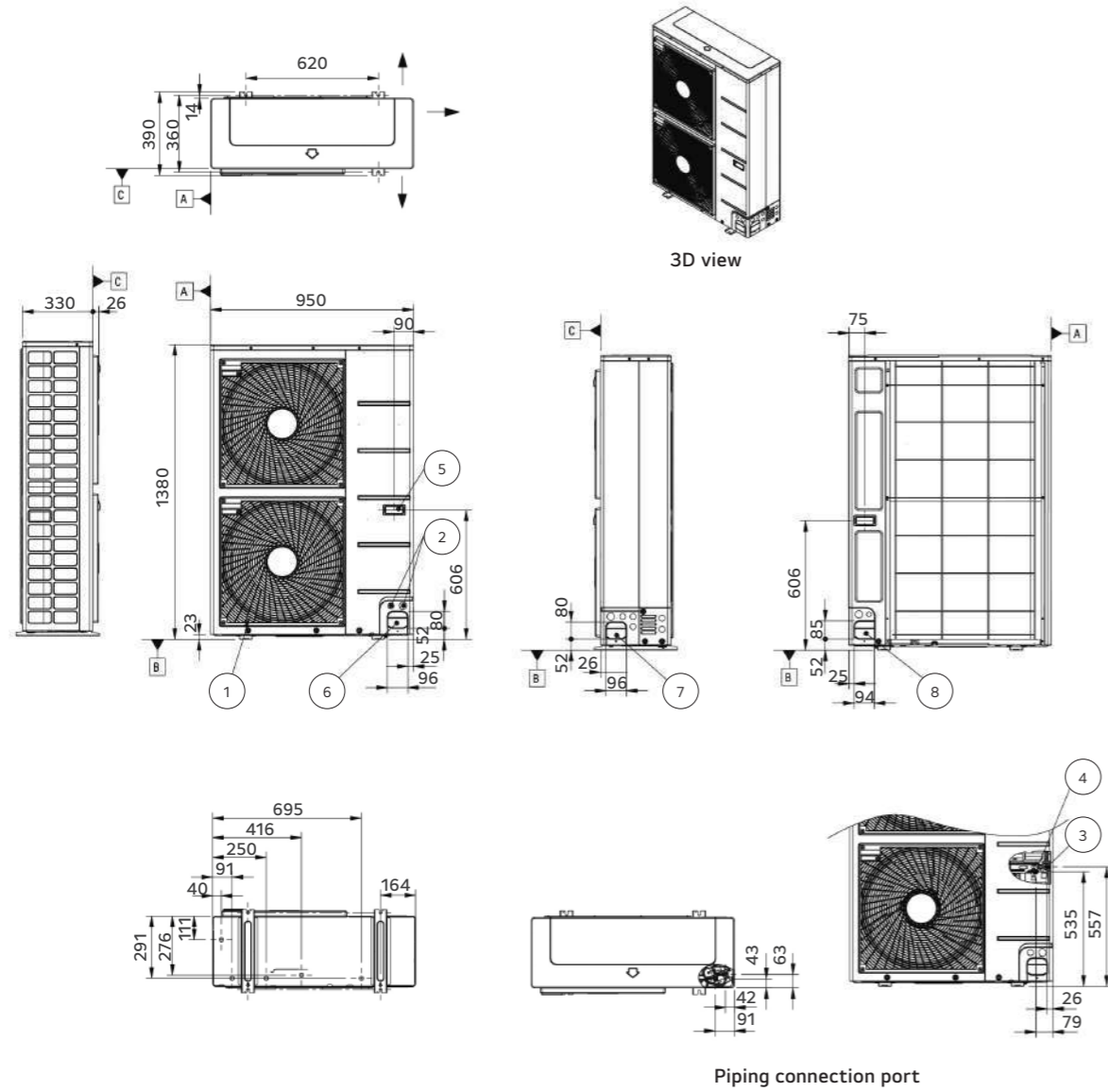

No.	Part name	Description
1	Air outlet	-
2	Power and communication cable hole	-
3	Gas pipe connection	Flare joint
4	Liquid pipe connection	Flare joint
5	Handle	-
6	Pipe routing hole (front)	-
7	Pipe routing hole (side)	-
8	Pipe routing hole (back)	-

HN1616M NK5 / HN1636M NK5

[Unit: mm]

External

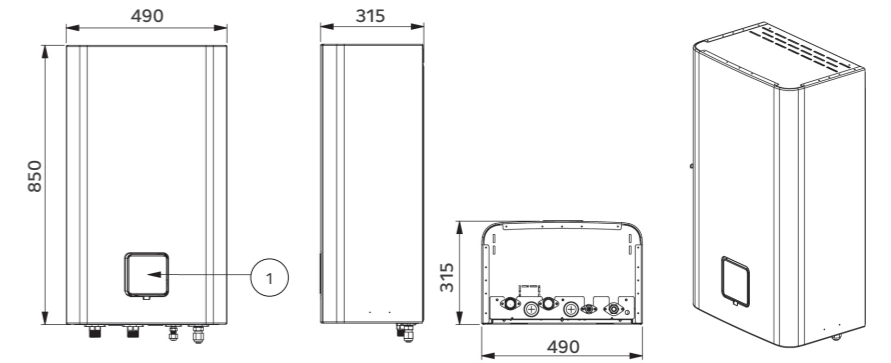

No.	Part name	Description
1	Control panel	Built-in remote controller

Internal

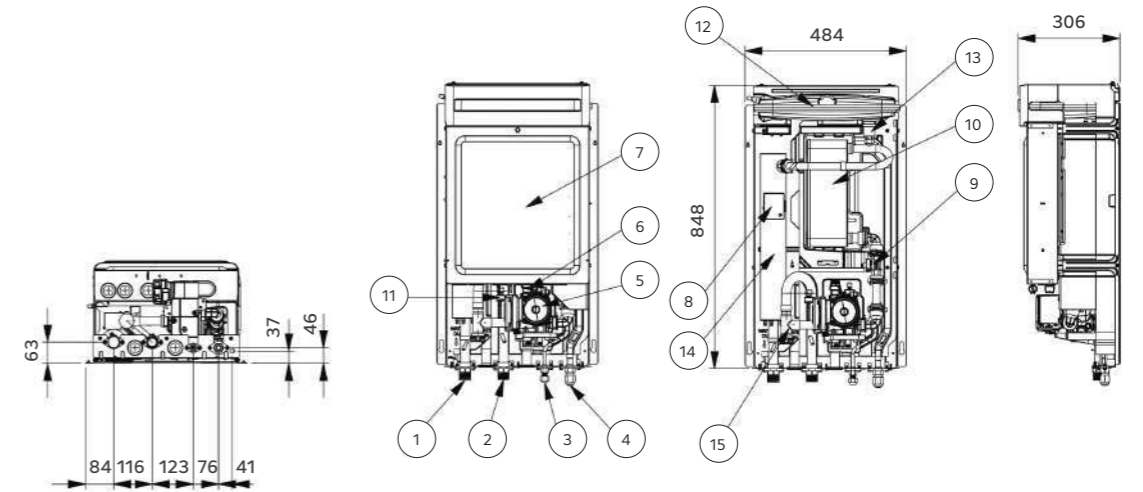

No.	Part name	Description
1	Leaving water pipe	Male PT 1" according to ISO 7-1 (tapered pipe threads)
2	Entering water pipe	Male PT 1" according to ISO 7-1 (tapered pipe threads)
3	Refrigerant pipe (liquid)	Ø 9.52 (mm)
4	Refrigerant pipe (Gas)	Ø 15.88 (mm)
5	Water pump	To circulate water inside the system
6	Safety valve	Open at water pressure 3 bar
7	Control box	PCB and terminal blocks
8	Thermal switch	Cut-off power input to electric heater at 90°C
9	Flow sensor	To measure the water flow rate (5-80 LPM)
10	Plate heat exchanger	Heat exchange between refrigerant and water
11	Pressure sensor	To measure the water pressure (0-2 MPa)
12	Expansion tank	Absorbing volume change of heated water
13	Air vent	Air purging when charging water
14	Backup heater	6 kW
15	Strainer	Filtering and stacking particles inside circulating water

THERMA V™

Hot Water Heat Pump





Eco-Conscious
Hot Water
Solution



What is the Hot Water Heat Pump?

With an increasing emphasis on eco-conscious energy solutions, the Hot Water Heat Pump obtains 75% of its energy from outside air. This renewable energy source produces domestic hot water using two heat exchangers, a condenser and an evaporator.

Product Range

Phase Supply	Capacity (l)	Model	Appearance
1 Ø 230 V	200	WH20S	
	270	WH27S	

Key Components

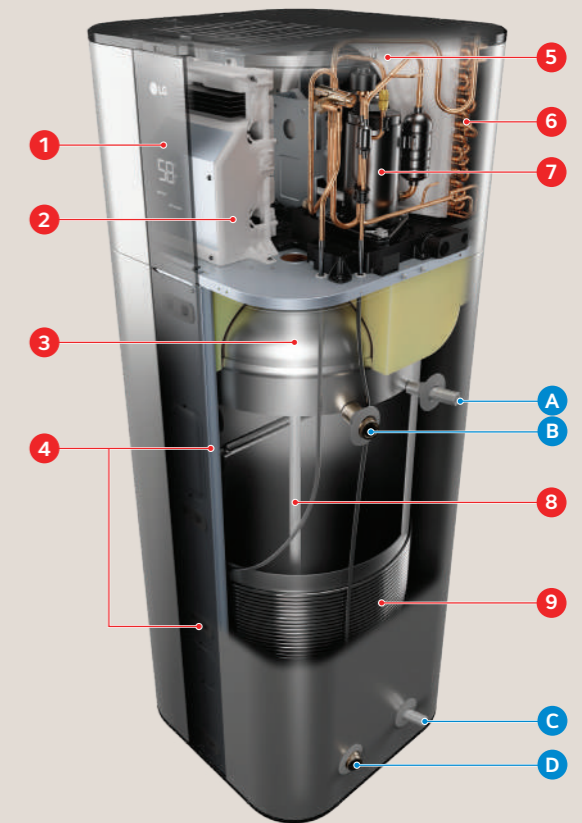

Components

- 1 Display screen
- 2 Inverter drive
- 3 Water tank
- 4 Electric heaters, 2 x 2 kW
- 5 Fan
- 6 Evaporator
- 7 Dual inverter compressor
- 8 Anode (ICCP)
- 9 Ref. piping coil

Connections

- A Water outlet (NPT 3/4")
- B Opening for T&P relief valve
- C Water inlet (NPT 3/4")
- D Opening for drain valve

THERMA V™ HIGHLIGHT OF HOT WATER HEAT PUMP



[Browse now](#)

Stylish Design

LG unit's exclusive square shape and luxury silver color make it an excellent fit for any interior design.



Differentiated design

LG's exclusive square design and sophisticated color scheme complement any interior.

iF design award 2020

Reddot design award 2020



Top Class Energy Efficiency

LG's Hot water heat pump with the highly efficient DUAL Inverter Compressor allows for impressive energy savings of over 70 % compared to a conventional electric heater.

Energy saving

Benefiting from the market's first DUAL Inverter Compressor, LG Hot water heat pump can run at low rotational speed (up to 10 Hz), reducing energy consumption by 70 % more than an electric water heater (250 l, C class).

Average estimated energy consumption savings per year



※ Simulation data on daily electricity consumption, based on EU climate conditions (average, 15°C).
 ※ The data are based on LG internal simulation.
 ※ The data are depending on the experimental conditions and is changeable according to the usage environment

Powerful Heating Performance

The DUAL Inverter Compressor maximizes the heat pump's power in turbo mode for a 30 % faster heating time for first-use water than in auto operation mode.

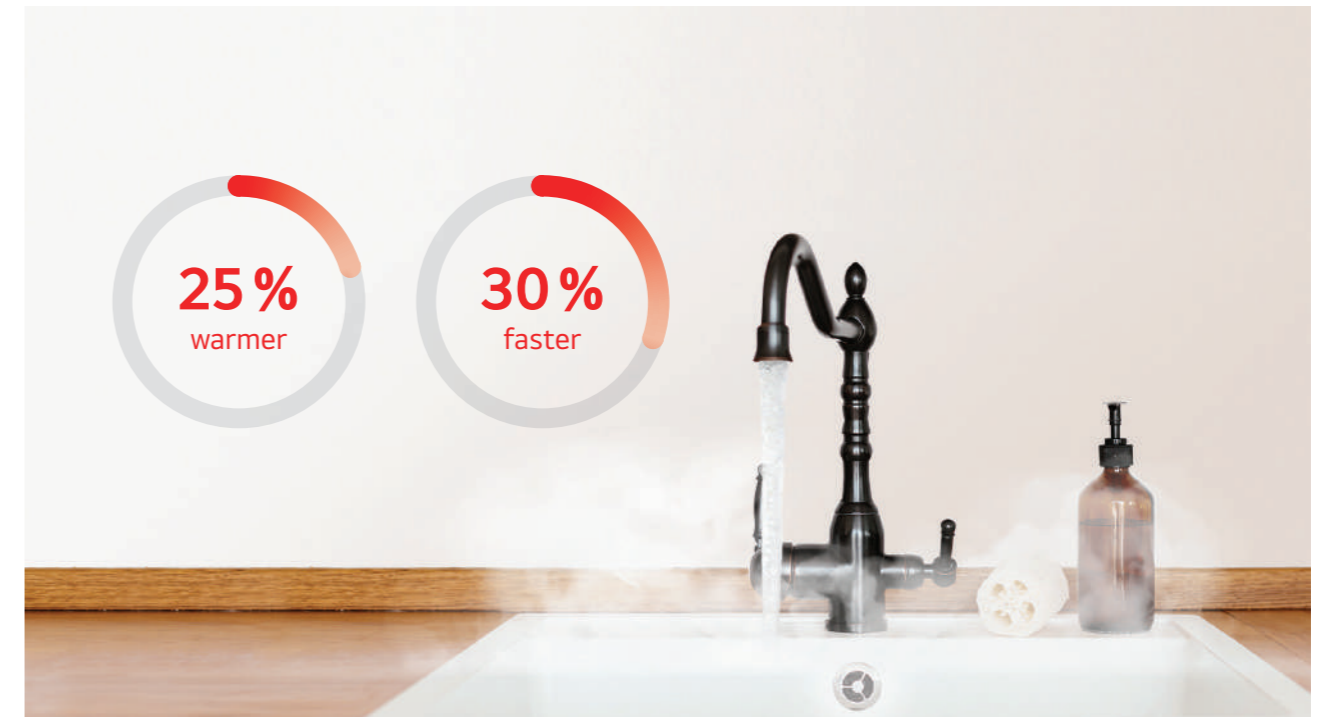

Fast & powerful water heating

Turbo mode can run at high speeds (up to 80 Hz) with simultaneous heating. The target water temperature in the tank will be achieved 30 % faster in turbo mode compared to Auto mode. The tank will be heated within one hour - starting with a cold tank.

Furthermore, if Turbo mode is used, the hot water can be heated to a higher temperature - leading to 25% more stored heat - compared to Auto mode.

Note: Obviously, this means increased usage of backup heater and more energy consumption, too. Thus, Turbo mode should be used only at peak load.

※ The data are based on LG internal tests and simulations.
 ※ The data depend on the experimental conditions and are changeable according to the usage environment.

Continuous operation

The two heat sources, two heaters and a heat pump complement each other perfectly. If the heat pump or one of the heaters fails, the other heat source allows alternative operation.

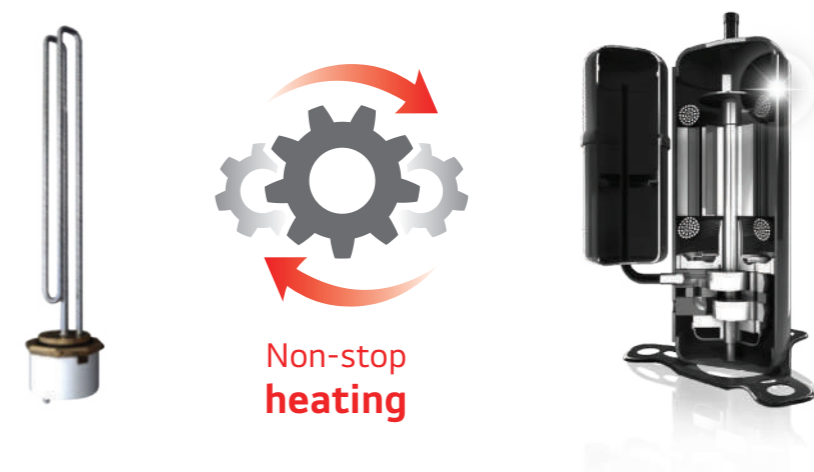

THERMA V™

HIGHLIGHT OF HOT WATER HEAT PUMP

Low Noise Operation

Through BLDC motor and DUAL Inverter Compressor, noise is reduced to 53 dB(A) (sound power) and provides a comfortable environment even in indoor installation scenes.

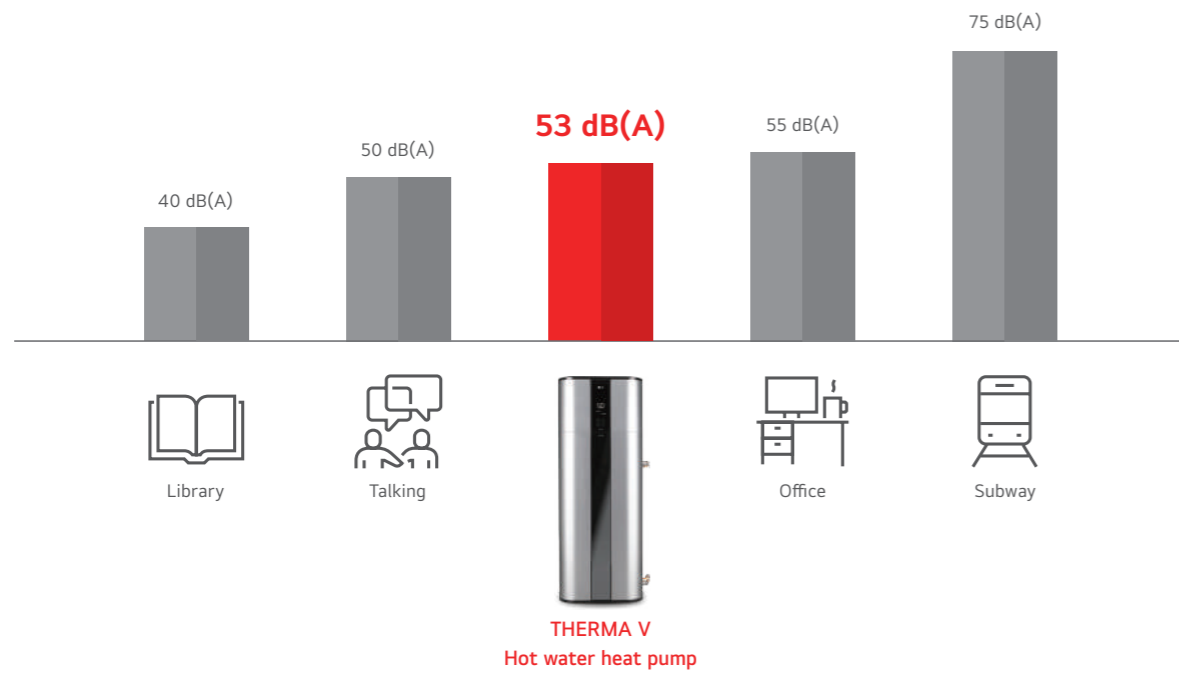

※ Sound pressure is 38 dB(A) based on LG internal test.
 ※ The data are based on LG internal test (sound power).
 ※ The data are based on LG internal tests and simulations.
 ※ The data are depending on the experimental conditions and is changeable according to the usage environment.

Various Operation Mode

LG Hot Water Heat Pump can be operated in four different modes for different conditions.

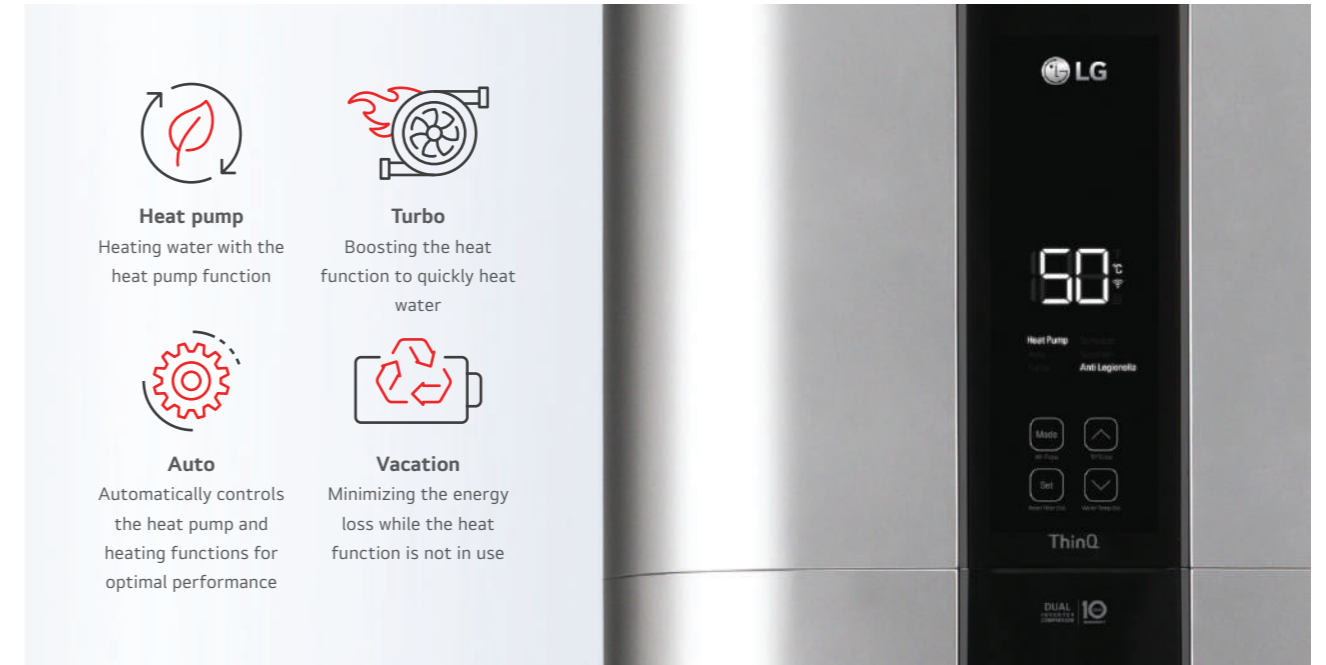

Operation



Using basic control

Display screen

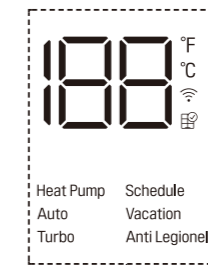

Display screen

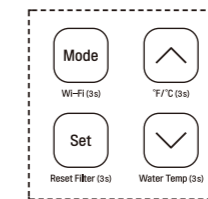

Button

Button	Display screen	Description
Mode	Heat pump	To select the heat pump mode
	Auto	To select the auto mode
	Turbo	To select the turbo mode
	Vacation	To select the vacation mode
-	Schedule	Set schedule mode only in LG ThinQ application
-	Anti legionella	To select the anti legionella mode
Set	-	To set the desired water temperature
↑ ↓	18.8	To adjust the desired water temperature
Wi-Fi (3s)	Wi-Fi icon	To enable the Wi-Fi pairing
Reset Filter (3s)	Filter icon	To reset the filter alarm
°F/°C (3s)	°F / °C	To change unit between °F and °C
Water Temp (3s)	18.8	To display the current water temperature for 5 seconds

THERMA V™ HIGHLIGHT OF HOT WATER HEAT PUMP

Harmony with Various Installation Places

LG's unique design provides standalone installation and harmony in various installation places.



Garage



Laundry room



Basement



Storage room



Bathroom



Bathroom

※ This image is intended to help you understand, and there may be some differences in actual use.

Smart Control

With the LG ThinQ smartphone app, users can easily control and monitor the heat pump, checking for current water temperatures, setting operating schedules and more.



Embedded Wi-Fi

You can control the LG ThinQ app, checking information such as current water temperature, operating mode and more.

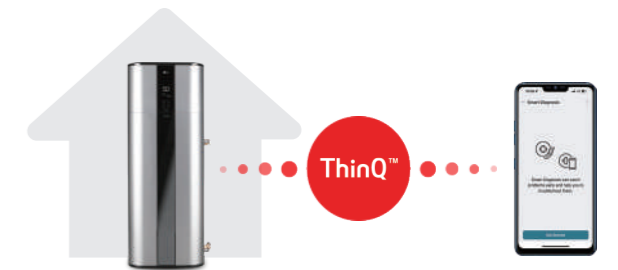

Smart diagnosis

Smart diagnosis allows users to conveniently check setup, installation, troubleshooting and other information directly from a smartphone.



Easy check & monitoring

Easily comprehensible error messages make detecting a solution and contacting the service center simple and convenient.



THEIRMA V™ HIGHLIGHT OF HOT WATER HEAT PUMP

powered by
DUAL Inverter Compressor™

LG's DUAL Inverter Compressor™ - exceptional in the market - saves energy with a wide power-saving operating range and produces efficient heating, performing quietly even in max operation mode. This technology allows the inverter compressor to achieve superior energy efficiency, cooling performance and comfort compared to compressors with on-off capabilities which is rare for monobloc heat pump water heaters.



Varied-speed dual rotary

A compressor motor has a wider energy efficient rotational frequency and a higher volumetric quick cooling capacity compared to a conventional non-inverter compressor.

Product reliability improvement

As twin rotaries balance each other while they are rotating with high speed, it reduces noise dramatically compared to a shaking single rotary compressor. The reduction in vibration reduces the possibility of fractures occurring in the surrounding pipework.

※ The data are based on LG internal test and simulation.
※ The data depend on the experimental conditions and are changeable according to the usage environment

Benefit & verification

Reliable air conditioner
The product safety is guaranteed with a 10-year warranty offered to customers.



Verification
TUV Rheinland, long term accelerated-reliability test & high marginal test



※ Long term accelerated-reliability test
LG's unique testing method with reinforced operating condition for a product life assurance to test and determine the product life cycle in a short period of time by accelerating the life cycle.
※ High marginal test
Test method to secure durability in various adverse conditions that may occur in the field by performing compressor reliability test against higher pressure and temperature than the designed range of pressure and temperature which the compressor operates in.
※ Verification obtained from TUV Rheinland for 10-year product life cycle.

Quick & Easy Installation

The machine's one-direction inlet and outlet piping and easy-to-connect wires in the junction box allow for quick and easy installation. Furthermore, the LG ThinQ app provides service alarm and self diagnosis programs for convenient maintenance.



10-year warranty

The core parts of Hot water heat pump such as water tank and compressor are certified for 10-year durability by TUV Rheinland. ceramic coating inside the water tank meets Germany ceramic standard DIN 4753 and guarantees 10 years of corrosion resistance.



※ Other parts warranty may vary according to after sales service condition

THERMA V™ HOT WATER HEAT PUMP



Technical Specification

Sales model	Unit	WH20S	
Factory model		R5TT20F-SA1	
Capacity	Volume (nominal)	ℓ	200
Energy efficiency ¹⁾	COP (7°C / 15°C)		3.30 / 3.50
Energy consumption	Annual energy consumption (7°C / 15°C)	kWh	756 / 709
Load profile			Large
Power input	Upper element wattage (230 V)	kW	2
	Lower element wattage (230 V)	kW	2
Energy efficiency class (7°C / 15°C)			A+ / A+
Power supply	V, ∅, Hz		230 / 1 / 50
Available voltage range	V		195 ~ 265
Operating mode			Turbo / Auto / Heat pump / Vacation / Anti legionella
Air flow rate	H / M	m³/min	6.7 / 4.4
	H / M	CFM	236.6 / 155.4
Sound pressure level	Auto	dB(A)+3	38
Sound power level		dB(A)	55
Dimensions	Net (H x W x D)	mm	1,625 x 580 x 582
Weight	Net	kg	100
Nominal insulation thickness	Min. / Max.	mm	40 / 80
Heat pump operation range	Min. / Max.	°C DB	-5 / 48
Exterior color / RAL code			Luxury silver / RAL 9006
Compressor	Type		Inverter twin rotary
	Warranty	Year	10
	Manufacturer		LG Electronics
	Motor output	W	510
Max. working pressure (water tank)			150 PSI (1,034 kPa)
Circuit breaker		A	15
Condensate water connection	I.D	mm	19, 12.7
V40 (Mixed water at 40°C)		ℓ	260
Refrigerant	Type		R134a
	Pre charge	kg	0.650
	GWP		1,430
	t-CO ₂ eq		0.930
Defrost method			Reverse cycle
Anode			Impressed current cathodic protection
T&P relief valve			Yes
Water connection location			side
Water connection size		inch	G ¾ M
Digital display			Yes
Wi-Fi (LG ThinQ) ²⁾			Yes
Tank warranty		Year	10

1) Water heater energy efficiency (at auto mode)
 2) ThinQ main function
 - Operation mode (auto, heatpump, turbo, vacation, schedule), temperature setting
 - Monitoring hot water temperature
 - Maintenance point alarm (filter, anode rod, etc.)
 ※ This product contains fluorinated greenhouse gases (R134a).
 ※ GWP: Global Warming Potential
 ※ t-CO₂eq: F-gas (kg)*GWP/1000
 ※ Specification, design and feature are subject to change without prior notice.

Technical Specification



Sales model	Unit	WH27S	
Factory model		R5TT27F-SA0	
Capacity	Volume (nominal)	ℓ	270
Energy efficiency ¹⁾	COP (7°C / 15°C)		3.45 / 3.85
Energy consumption	Annual energy consumption (7°C / 15°C)	kWh	712 / 646
Load profile			Large
Power input	Upper element wattage (230 V)	kW	2
	Lower element wattage (230 V)	kW	2
Energy efficiency class (7°C / 15°C)			A+ / A++ ²⁾
Power supply	V, ∅, Hz		230 / 1 / 50
Available voltage range	V		195 ~ 265
Operating mode			Turbo / Auto / Heat pump / Vacation / Anti legionella
Air flow rate	H / M	m³/min	6.7 / 4.4
	H / M	CFM	236.6 / 155.4
Sound pressure level	Auto	dB(A)+3	38
Sound power level		dB(A)	55
Dimensions	Net (H x W x D)	mm	2,008 x 580 x 582
Weight	Net	kg	119
Nominal insulation thickness	Min. / Max.	mm	40 / 80
Heat pump operation range	Min. / Max.	°C DB	-5 / 48
Exterior color / RAL code			Luxury silver / RAL 9006
Compressor	Type		Inverter twin rotary
	Warranty	Year	10
	Manufacturer		LG Electronics
	Motor output	W	510
Max. working pressure (water tank)			150 PSI (1,034 kPa)
Circuit breaker		A	15
Condensate water connection	I.D	mm	19, 12.7
V40 (Mixed water at 40°C)		ℓ	360
Refrigerant	Type		R134a
	Pre charge	kg	0.750
	GWP		1,430
	t-CO ₂ eq		1.072
Defrost method			Reverse cycle
Anode			Impressed current cathodic protection
T&P relief valve			Yes
Water connection location			side
Water connection size		inch	G ¾ M
Digital display			Yes
Wi-Fi (LG ThinQ) ²⁾			Yes
Tank warranty		Year	10

1) Water heater energy efficiency (at auto mode)
 2) Energy label marked A+ and more than COP 3.75 in EU standard is A++
 3) ThinQ main function
 - Operation mode (auto, heatpump, turbo, vacation, schedule), temperature setting
 - Monitoring hot water temperature
 - Maintenance point alarm (filter, anode rod, etc.)
 ※ This product contains fluorinated greenhouse gases (R134a).
 ※ GWP: Global Warming Potential
 ※ t-CO₂eq: F-gas (kg)*GWP/1000
 ※ Specification, design and feature are subject to change without prior notice.

THERMA V™ HOT WATER HEAT PUMP

Drawings

WH20S

[Unit: mm]

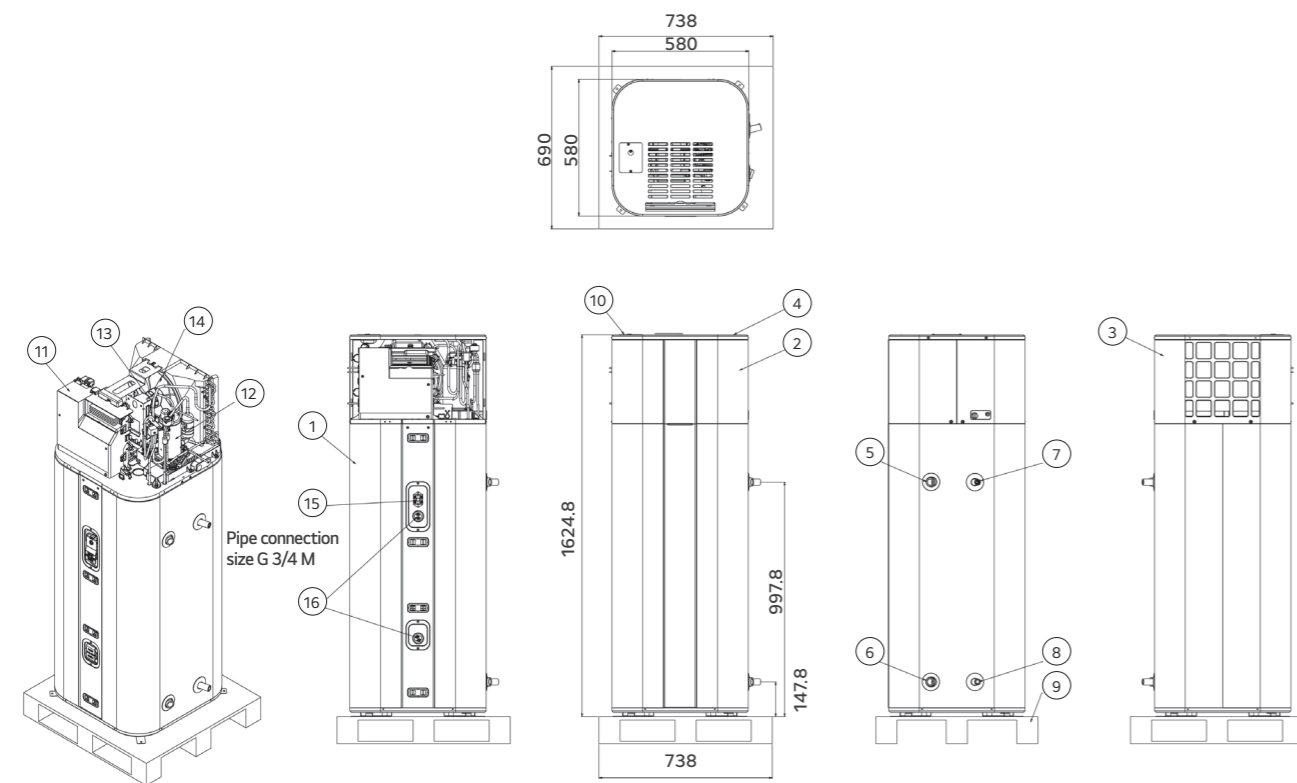

No.	Part name	Description
1	Water tank	200 ℓ
2	Front panel	-
3	Rear panel	-
4	Top cover	-
5	T/P valve	210 °F / 99 °C 3/4 NPT
6	Drain valve	3/4 NPT
7	Outlet pipe	Water out, 3/4 NPT
8	Inlet pipe	Water in, 3/4 NPT

No.	Part name	Description
9	Wooden pallet	-
10	Junction cover	Power input
11	C/B case	-
12	Compressor	EST092MBA
13	Motor	43 W
14	Fan propeller	290 Ø
15	ECO	Emergency cut off (77°C)
16	Heater	2 EA, 2000 W+2000 W, 220 ~ 240 V

WH27S

[Unit: mm]

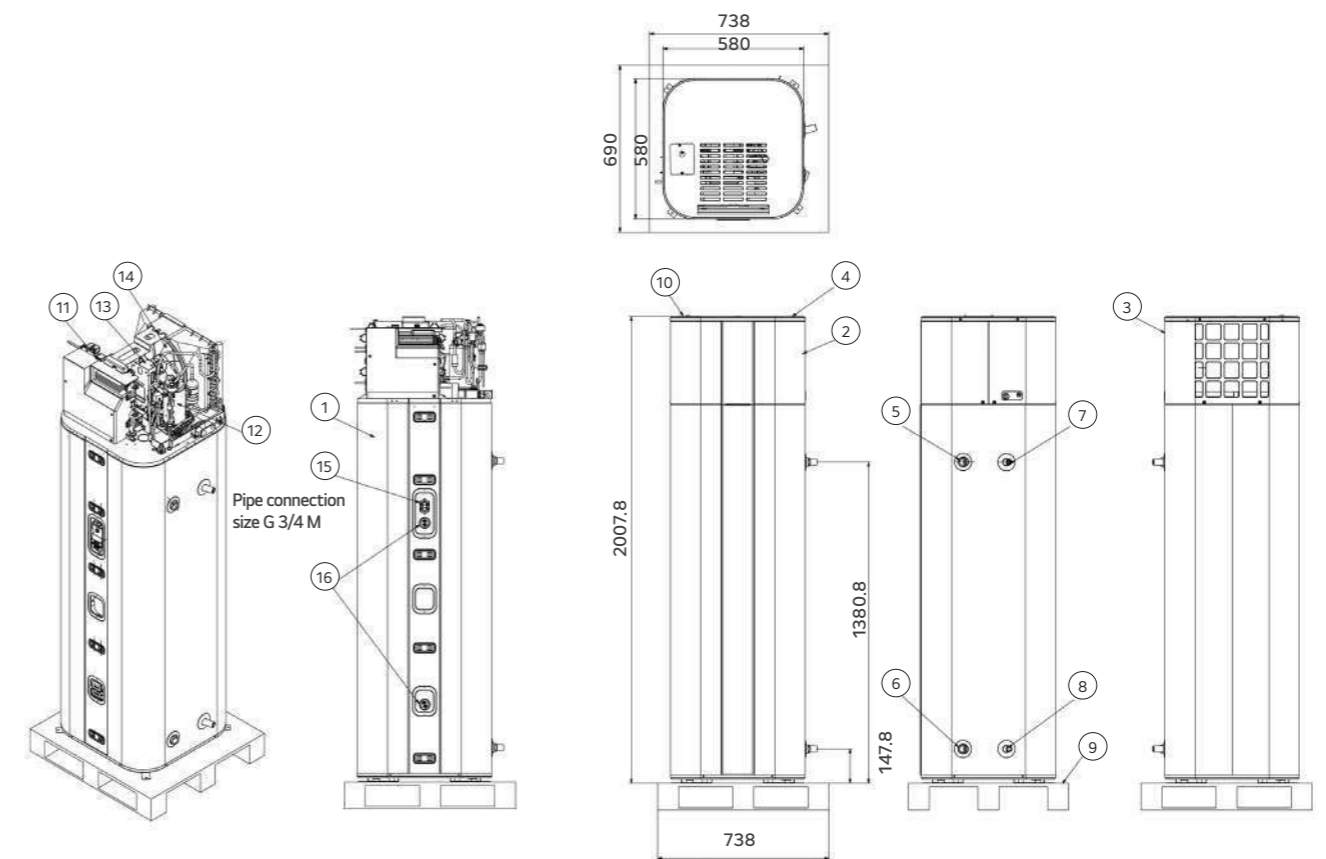

No.	Part name	Description
1	Water tank	270 ℓ
2	Front panel	-
3	Rear panel	-
4	Top cover	-
5	T/P valve	210 °F / 99 °C 3/4 NPT
6	Drain valve	3/4 NPT
7	Outlet pipe	Water out, 3/4 NPT
8	Inlet pipe	Water in, 3/4 NPT











No.	Part name	Description
9	Wooden pallet	-
10	Junction cover	Power input
11	C/B case	-
12	Compressor	EST092MBA
13	Motor	43 W
14	Fan propeller	290 Ø
15	ECO	Emergency cut off (77°C)
16	Heater	2 EA, 2000 W+2000 W, 220 ~ 240 V

THEIRMA V™ ACCESSORIES









ACCESSORIES PROVIDED BY LG	164
LG WI-FI MODEM	168
DOMESTIC HOT WATER TANK	169
COMBINED TEST WITH DHW TANK	170

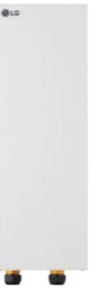





Accessories Provided by LG

Category	Model name	Model number	Figure	Applicable product	Relevant function	Purpose	Feature
Sensors	Room temperature sensor	PQRSTA0		All THERMA V products	Room temperature based control	To detect room air temperature for room temperature based control	• Max. wire length: 15 m
	Thermistor for 2 nd circuit or e/heater	PRSTAT5K10		All except for High Temperature	2 nd circuit (mixing circuit)	To detect 2 nd circuit temperature when using 2 nd circuit function	• 5 kΩ thermistor, 10 m
	Outdoor air temperature sensor	PHATSO ¹⁾		R290 Monobloc	Weather-dependent operation	To detect outdoor air temperature more accurately for weather-dependent operation especially when the outdoor unit is exposed to sunlight	• Max. wire length: 12 m • optional accessory - i.e pre-installed air sensor (mounted at grille of outdoor unit) will be used for weather-dependent operation if the outdoor air temperature sensor is not installed
	Water tank sensor	PHRSTA0 ¹⁾		All except for R32 Split Combi Unit and R32 Hydrosplit Combi Unit R290 Monobloc	Domestic hot water heating Buffer tank temperature based control	To detect DHW tank temperature To detect the temperature at the top of the buffer tank or at its outlet pipe if a big buffer tank is connected in parallel to the heat pump	• Included in DHW tank kit • Max. wire length: 12 m * A harness that can be connected to PCB-connector TB_SENSOR/BUFFER is included in this accessory produced after 1st of March 2024.
Valves	3 way valve	OSHA-3 V		All except Combi Units (incl. R290 Monobloc)	Domestic hot water heating	To divert water flow between space heating and DHW heating	• Size: DN 20 G 1" connection, male threaded
	Thermostatic mixing valve	OSHA-MV OSHA-MV1		Regardless of the model	Domestic hot water supply	To blend hot water with cold water for ensuring constant, safe shower and bath outlet temp.	• Size: 3/4" DN20 male threaded • Size: 1" DN25 male threaded
DHW tanks	Domestic hot water tank (single coil)	OSHW-200 F OSHW-300 F OSHW-500 F		All except Combi Units	Domestic hot water heating	To generate and store domestic hot water	• Storage volume: 200 ℓ, 300 ℓ, 500 ℓ • Type: internal single coil • Material: stainless steel • Capacity of booster heater: 2.4 kW
	Domestic hot water tank (double coil)	OSHW-300 FD		All except Combi Units and High Temperature model	Domestic hot water heating	To generate and store domestic hot water	• Storage volume: 300 ℓ • Type: internal double coil • Material: stainless steel • Capacity of booster heater: 2.4 kW
Installation kits	Domestic hot water tank kit	PHLTA PHLTC PHLTB		Hydro Unit for Split & Hydrosplit Old Hydro Unit for R410A Split - 3 Ø (HN1639 NK3 only)	Domestic hot water heating	To control an external DHW booster heater	• Parts included: DHW tank sensor (thermistor), circuit breaker, relay • Parts included: DHW tank sensor (thermistor), circuit breaker, relay, multi harness
	Solar thermal kit	PHLLA		R32 Split 4/6 kW Hydro Unit (HN0613M NK5), R32 Monobloc, R410A Split Hydro Unit (HN1616 NK3 / HN1639 NK3)	Solar thermal heat utilization	To operate with solar thermal system	• Length of thermistor: 12 m • Size of tube connector (W x H x D): 110 x 55 x 22







1) These accessories are under developments, those will be launched 2Q 2024.

Category	Model name	Model number	Figure	Applicable product	Relevant function	Purpose	Feature
Installation kits	Electric back-up heater	HA031M E1		R290 Monobloc Control Unit, R32 Monobloc, R32 Monobloc S	Capacity back up & emergency operation	To supplement insufficient capacity	• Heater capacity: 3 kW • Number of heating coil: 1ea (3.0 kW) • Size (W x H x D): 210 x 607 x 217 • Power: 220 - 240 V, 1 Ø
		HA061M E1					• Heater capacity: 6 kW • Number of heating coil: 2 ea (3.0 + 3.0 kW) • Size (W x H x D): 210 x 607 x 217 • Power: 220 - 240 V, 1 Ø
		HA063M E1					• Heater capacity: 6 kW • Number of heating coil: 3 ea (2.0 + 2.0 + 2.0 kW) • Size (W x H x D): 210 x 607 x 217 • Power: 380 - 415 V, 3 Ø
	HA061C E1		R32 Hydrosplit Hydro Unit (HN1600MC NK1)	Capacity back Up & emergency operation	To supplement insufficient capacity	• Heater capacity: 6 kW • Number of heating coil: 2 ea (3.0 + 3.0 kW) • Power: 220-240 V, 1 Ø	
	HA063C E1					• Heater capacity: 6 kW • Number of heating coil: 3 ea (2.0 + 2.0 + 2.0 kW) • Power: 380-415 V, 3 Ø	
Vessel	Buffer tank for space heating	OSHB-40KT		R32 Hydrosplit Combi Unit	-	To provide the buffer volume of water to the heating circuit	• Volume: 40 ℓ • Size (W x H x D): 518 x 560 x 175
	Expansion vessel for DHW	OSHE-12KT		R32 Hydrosplit Combi Unit	-	To absorb the pressure variations in the DHW tank due to changing temperatures	• Volume: 8 ℓ • Connection: 3/4" • Max. pressure: 10 bar • Size (W x H x D): 416 x 238 x 502
ETC	Extension wire for a wired remote controller	PZCWRC1		All THERMA V products	-	To extend the wire between the wired remote controller and the indoor unit	• Length: 10 m
	Extension cable for Wi-Fi modem	PWYREW000		All THERMA V products	Wi-Fi control via LG ThinQ	To extend a wire between the Wi-Fi modem and the indoor unit	• Length: 10 m
	2-remote control wire	PZCWRC2		All THERMA V products	2 remote control	To connect an additional remote controller (Slave)	• Length: 0.25 m
	Drain pan	PHDPB		R32 Split Hydro Unit (NK4 suffix), R410A Split Hydro Unit (NK3 suffix)	Cooling operation	To collect condensed water in the indoor unit during the cooling operation	-
		PHDPC					R290 Monobloc, R32 Hydrosplit, R32 Split Hydro Unit (NK5 suffix), R410A Split Hydro Unit (NK5 suffix)
Cover plate	PDC-HK10		R290 Monobloc, R32 Hydrosplit Hydro Unit, R32 Hydrosplit Combi Unit, R32 Split Hydro Unit, R32 Split Combi Unit, R410A Split Hydro Unit	-	To fill the blank space of the indoor unit front panel when the remote controller is relocated indoors.	-	

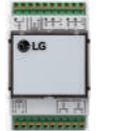
Accessories Provided by LG

Category	Model name	Model number	Figure	Applicable product	Relevant function	Purpose	Feature
Remote controller	Wired remote controller	PREMTW101		All THERMA V products	2 remote control	To control the AWHP using two remote controllers (an additional remote controller)	<ul style="list-style-type: none"> New modern design 4.3 inch color LCD display Information displayed with simple graphic, icon & text Built-in temperature sensor Size (W x H x D): 120 x 120 x 16 Extension cable (PZCWRC1, 9.6 m) and 2 remote cable (PZCWRC2, 0.25 m) are included
Central controller	AC Ez Touch ¹⁾	PACEZA000		All THERMA V products except for R290 Monobloc	Centralized control	To control the AWHP using LG central controller	<ul style="list-style-type: none"> 5 inch color display User-friendly control with iconographic interface (touch screen) Max. 32 unit control Total 200 schedule events (weekly / monthly / yearly / exception day) Operation history Remote controller lock (all, temp, mode) PC access supported (IPv6 supported) DI 1 ea (emergency stop only) Size (W x H x D): 137 x 121 x 25
	AC Smart 5 ¹⁾	PACSA000					<ul style="list-style-type: none"> 10.2 inch color display User-friendly control with iconographic interface (touch screen) Max. IDU 64 Total 100 schedule events (weekly / monthly / yearly / exception day) History / operation trend Interlock with 3rd party equipment (ACS IO, ACU IO module is needed) Error alarm by e-mail Remote controller lock (all, temp, mode) Map view (visual navigation) Web access supported with HTML5 (PC, smartphone, tablet) DI 2 ea, DO 2 ea BACnet IP/modbus TCP protocol support Size (W x H x D): 253.2 x 167.7 x 28.9
	ACP 5 ¹⁾	PACP5A000					<ul style="list-style-type: none"> Web access controller Max. 128 unit control Total 100 schedule events (weekly / monthly / yearly / exception day) History / operation trend Interlock with 3rd party equipment (ACS IO, ACU IO module is needed) Error alarm by e-mail Remote controller lock (all, temp, mode) Map view (visual navigation) DI 10 ea, DO 4 ea BACnet IP/modbus TCP protocol support Lonworks protocol support* (max. 64 unit control) Size (W x H x D): 270 x 155 x 65

* For using Lonworks protocol, only ACP 5 provides interface for BMS integration, and, need to U60FT module between ACP 5 and BMS system interface between Lonworks FT-10 BMS and LG HVAC unit. U60FT should be purchased separately from 3rd party supplier. Please contact regional LG office for more detailed information.

Category	Model name	Model number	Figure	Applicable product	Relevant function	Purpose	Feature
Gateway	Modbus RTU gateway	PMBUSB00A		All THERMA V products	Centralized control	To communicate and control through the central controller (providing modbus RTU connection between the AWHP and BMS)	<ul style="list-style-type: none"> Modbus RTU slave (RS485) / 9,600 bps Size (W x H x D): 53.6 x 89.7 x 60.7 Max. 16 IDUs with single module / Max. 64 IDUs with 4 modules Power: DC 12 V
	PI485 gateway for THERMA V ¹⁾	PP485A00T					<ul style="list-style-type: none"> 1 for each outdoor unit Power: supplied by outdoor unit
Dry contact	Simple dry contact	PDRYCB000		All THERMA V products		To connect between the AWHP and external devices to control various functions	<ul style="list-style-type: none"> 1 Set per 1 unit 1 Input contact for turning on/off Input power: 220 ~ 240 V 2 output contacts <ul style="list-style-type: none"> Operation status Error status
	Dry contact for thermostat	PDRYCB320					<ul style="list-style-type: none"> 1 Set per 1 unit Non voltage or 12 ~ 24 V 8 digital input contacts for thermostat <ul style="list-style-type: none"> On/off, operation mode, DHW heating Emergency mode, silent mode 2 Output contacts <ul style="list-style-type: none"> Operation status Error status
ETC	LG Wi-Fi modem	PWFMD200		All THERMA V products	Wi-Fi control via LG ThinQ	To control the AWHP via a smartphone	<ul style="list-style-type: none"> Basic control function <ul style="list-style-type: none"> On/off, operation mode, set temp DHW heating and set temp Weekly on/off schedule Error status check Frequency: 2.4 GHz IEEE 802.11b/g/n supported
	Cloud gateway ¹⁾	PWFMD200		R290 Monobloc, R32 Monobloc S, R32 Split Combi Unit, New Hydro Unit for Split & Hydrosplit	LG BECON cloud service	For remote control, monitoring and diagnosis	<ul style="list-style-type: none"> Max 16 indoor units RS485: 1 channel (LGAP) Wired/wireless LAN Power: 12 V DC Size (W x H x D): 120 x 120 x 29
	Meter interface	PENKTH000		All THERMA V products	Energy monitoring	To measure production / consumption power	<ul style="list-style-type: none"> Energy meter interface to monitor Electricity and Heat energy <ul style="list-style-type: none"> Max. 3 watt Hour meter Max. 1 heat meter Pulse width: 40 ms ~ 100 ms Modbus RTU comm. with THERMA V <ul style="list-style-type: none"> 2 wire RS485 / 9600 bps Power: DC 12 V Size (W x H x D): 54 x 90 x 61

¹⁾ PI485 Gateway (PP485A00T) should be installed on outdoor unit to use the central controller and cloud gateway. In the case of R290 Monobloc, PI485 G/W is built-in, so there is no need to purchase it separately.

LG Wi-Fi Modem

PWFMDD200 ENCXLEU

Access LG THERMA V anytime and from anywhere with a Wi-Fi equipped device. LG's exclusive home appliances control app (LG ThinQ) offers simple operation and various functions.

- On / Off
- Operation mode selection
- Current temperature
- Set temperature
- On / Off reservation scheduling
- Energy monitoring
- ESS monitoring
- Silent mode reservation
- Holiday mode
- Quick DHW heating

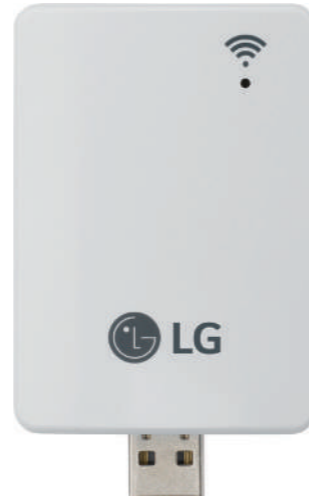

Model name	PWFMDD200
Size (mm)	46 x 68 x 14
Interfaceable products	All THERMA V line-ups
Connection type	Indoor unit 1 : 1
Communication frequency	2.4 GHz
Wireless standards	IEEE 802.11b/g/n
Mobile application	LG ThinQ (Android v7.0 (Nougat) or higher, iPhone iOS 11.0 or higher)
Optional extension cable	PWYREW000 (10 m extension)

Note

1. Functionality may be different according to each Indoor model.
2. User interface of application shall be revised for its design and contents improvement.
3. Application is optimized for smartphone use, so it may not be well functioning with tablet devices.
- For the compatibility with indoor unit, please contact regional office.

Domestic Hot Water Tank

OSHW-200F AEU

OSHW-300F AEU

OSHW-500F AEU

OSHW-300FD AEU



Single coil

Double coil

Technical specification		Unit	OSHW-200F	OSHW-300F	OSHW-500F	OSHW-300FD
General characteristics	Water volume	ℓ	200	300	500	300
	Diameter	mm	640	640	810	640
	Height	mm	1,350	1,850	1,900	1,850
	Empty weight	kg	61	100	146	106
	Tank materials	-	STS : F18	STS : F18	STS : F18	STS : F18
	Color	-	Grey (RAL 7035)	Grey (RAL 7035)	Grey (RAL 7035)	Grey (RAL 7035)
Specification of electric back up	Additional electric heater	W	2,400	2,400	2,400	2,400
	Power supply	V, Ø, Hz	230, 1, 50 (60)	230, 1, 50 (60)	230, 1, 50 (60)	230, 1, 50 (60)
	Adjustable thermostat	°C	0 ~ 90	0 ~ 90	0 ~ 90	0 ~ 90
Specification of heat exchanger	Exchanger type	-	Internal single coil	Internal single coil	Internal single coil	Internal double coil
	Material exchanger	-	STS : F18	STS : F18	STS : F18	STS : F18
	Maximum water temp.	°C	90	90	90	90
	Coil surface	m ²	2.3	3.1	4.8	3.1 + 1
Water connections	Heat pump inlet	inch	1 BSP female	1 BSP female	1 ¼ BSP female	1 BSP female (upper coil)
	Heat pump outlet	inch	1 BSP female	1 BSP female	1 ¼ BSP female	1 BSP female (upper coil)
	Solar inlet	inch	-	-	-	¾ BSP Female (lower coil)
	Solar outlet	inch	-	-	-	¾ BSP Female (lower coil)
	City water inlet	inch	¾ BSP male	¾ BSP male	1 BSP male	¾ BSP male
	Hot water outlet	inch	¾ BSP female	1 BSP female	1 BSP female	1 BSP female
Energy efficiency class (A+ to F scale)	-	B	B	B	B	
Standing heat loss	W	61	70	83	70	

Technical specification

Domestic hot water tank installation kit PHLTA (R290 Monobloc, Hydro Unit for Split & Hydrosplit), PHLTB (Monobloc), PHLTC (old Hydro Unit for R410A Split 3 Ø - HN1639 NK3)

Technical specification

Thermostatic mixing valve (3/4" DN20)	OSHA-MV
Thermostatic mixing valve (1" DN25)	OSHA-MV1
3 way valve	OSHA-3V

THERMA V™ ACCESSORIES

Combined Test With DHW Tank

LG has conducted a voluntary combination test of THERMA V with DHW tanks in accordance with EN16147 and obtained an ErP label for packages in accordance with the European nZEB regulations.

• R32 Monobloc S (5 ~ 16 kW) + OSHW-200 F

- HM051MR U44
- HM071MR U44
- HM091MR U44
- HM121MR U34
- HM141MR U34
- HM161MR U34
- HM123MR U34
- HM143MR U34
- HM163MR U34



Model	THERMA V line-up		R32 Monobloc S (5, 7, 9 kW)		R32 Monobloc S (12, 14, 16 kW)	
	Model name		HM051MR U44 HM071MR U44 HM091MR U44		HM121MR U34 HM141MR U34 HM161MR U34 HM123MR U34 HM143MR U34 HM163MR U34	
	DHW tank		OSHW-200F AEU		OSHW-200F AEU	
Declared load profile						
L						
Average climate	Water heating eff. class	A+		A+		
	Water heating efficiency (η_{WH})	144 %		146 %		
	COP _{DHW}	3.1		3.2		
	Annual energy consumption	712 kWh		701 kWh		
Warmer climate	Water heating eff. class	A++		A++		
	Water heating efficiency (η_{WH})	174 %		166 %		
	COP _{DHW}	3.8		3.6		
	Annual energy consumption	588 kWh		616 kWh		
Colder climate	Water heating eff. class	A		A		
	Water heating efficiency (η_{WH})	87 %		101 %		
	COP _{DHW}	1.9		2.2		
	Annual energy consumption	1,172 kWh		1,011 kWh		
Energy label						

